

RS16FS | User's Guide

Version 6.1A

Preface

About this manual

This manual is the introduction of **RS16FS** controller and it aims to help users know the operations of the disk array system easily. Information contained in this manual has been reviewed for accuracy, but not for product warranty because of the various environments/OS/settings, Information and specification will be changed without further notice. For any update information, please visit www.Proavio-tech.com and your contact windows.

Copyright@2008, Proavio, U.S.A. All rights reserved.

Thank you for using **Proavio, U.S.A.**, products; if you have any question, please e-mail to “support@proavio.com”. We will answer your question as soon as possible.

Table of Contents

Chapter 1	RAID introduction.....	5
1.1	Features.....	5
1.2	Terminology	6
1.3	RAID levels	9
1.4	Volume relationship diagram	10
Chapter 2	Getting started	11
2.1	Before starting.....	11
2.2	Storage introduction.....	11
2.3	Management methods	12
2.3.1	Web GUI.....	12
2.3.2	Console serial port	13
2.3.3	Remote control – secure shell	13
2.4	Enclosure	13
2.4.1	LCM.....	13
2.4.2	System buzzer.....	15
2.4.3	LED	16
Chapter 3	Web GUI guideline	17
3.1	Web GUI hierarchy	17
3.2	Login	18
3.3	Quick install.....	19
3.4	System configuration	20
3.4.1	System setting.....	21
3.4.2	IP address	21
3.4.3	Login setting	22
3.4.4	Mail setting	23
3.4.5	Notification setting	24
3.5	Volume configuration	26
3.5.1	Volume create wizard.....	26
3.5.2	Physical disk.....	29
3.5.3	RAID group.....	32
3.5.4	Virtual disk.....	35
3.5.5	Snapshot	39
3.5.6	Logical unit	41
3.5.7	Example	42
3.6	Enclosure management.....	47
3.6.1	SES configuration.....	48
3.6.2	Hardware monitor	48
3.6.3	Hard drive S.M.A.R.T. support	49
3.6.4	UPS	50
3.7	System maintenance	52
3.7.1	System information.....	52
3.7.2	Upgrade.....	52
3.7.3	Reset to factory default.....	53

3.7.4	Import and export	53
3.7.5	Event log	54
3.7.6	Reboot and shutdown.....	55
3.8	Logout	55
Chapter 4	Advanced operation	56
4.1	Rebuild	56
4.2	RG migration	58
4.3	VD Extension	59
4.4	Snapshot / Rollback	60
4.4.1	Create snapshot volume.....	61
4.4.2	Auto snapshot	63
4.4.3	Rollback.....	64
4.5	Disk roaming	65
4.6	SAS JBOD expansion.....	65
4.7	Support Microsoft MPIO.....	68
Appendix	69
A.	Certification list.....	69
B.	Event notifications.....	71
C.	Known issues.....	75
D.	Installation steps for large volume (TB).....	75

Chapter 1 RAID introduction

1.1 Features

RS16FS controller is a high-performance RAID controller.

- Backplane solution
- Fibre Channel (FC x2) – to – SATA II/SAS (xN bays) RAID controller.

Features:

- Front-end 2-ported 4Gb FC ports with load-balancing & failover for high availability.
- RAID 6, 60 ready.
- Snapshot without relying on host software. (optional)
- SATA II drive backward-compatible.
- One logic volume can be shared by as many as 16 hosts.
- Host access control.
- Configurable N-way mirror for high data protection.
- On-line volume migration with no system down-time.
- HDD S.M.A.R.T. enabled for SATA drives.
- SAS JBOD expansion support.
- Microsoft VSS, VDS support. (optional)

With proper configuration, **RS16FS** controller can provide non-stop service with a high degree of fault tolerance by using **UltraStor** RAID technology and advanced array management features. The controller features are slightly different between the backplane solution and cable solution. For more details, please contact your direct sales or email to “sales@Proavio-tech.com”.

RS16FS controller connects to the host system in fibre channel interface. It can be configured to any RAID level. The controller provides reliable data protection for servers and **RAID 6**. The RAID 6 allows two HDD failures without producing any impact on the existing data. Data can be recovered from the existing data and parity drives. (Data can be recovered from the rest disks/drives.)

Snapshot-on-the-box is a fully usable copy of a defined collection of data that contains an image of the data as it appeared at the point in time, which means a point-in-time data replication. It provides consistent and instant copies of data volumes without any system downtime. **ULTRASTOR** Snapshot-on-the-box can keep up to 32 snapshots for all data volumes. **Rollback** feature is provided for restoring the previous-snapshot data easily while continuously using the volume for further data access. The data access which includes read/ write is working as

usual without any impact to end users. The "on-the-box" implies that it does not require any proprietary agents installed at host side. The snapshot is taken at target side and done by **ULTRASTOR** controller. It will not consume any host CPU time thus the server is dedicated to the specific or other application. The snapshot copies can be taken manually or by schedule every hour or every day, depends on the modification.

ULTRASTOR controller is the most cost-effective disk array controller with completely integrated high-performance and data-protection capabilities which meet or exceed the highest industry standards, and **the best data solution for small/medium business (SMB) users.**

	<p>Caution Snapshot / rollback features need 512MB RAM or more. Please refer to RAM certification list in Appendix A for more detail.</p>
---	--

1.2 Terminology

The document uses the following terms:

RAID	RAID is the abbreviation of “ R edundant A rray of I ndependent D isks”. There are different RAID levels with different degree of the data protection, data availability, and performance to host environment.
PD	The P hysical D isk belongs to the member disk of one specific RAID group.
RG	RAID group. A collection of removable media. One RG consists of a set of VDs and owns one RAID level attribute.
VD	Virtual disk. Each RG could be divided into several VDs. The VDs from one RG share the same RAID level, but may have different volume capacity.
CV	Cache Volume. Controller uses onboard memory as cache. All RAM (except for the part which is occupied by the controller) can be used as cache.

LUN	Logical Unit Number. A logical unit number (LUN) is a unique identifier which enables it to differentiate among separate devices (each one is a logical unit).
GUI	Graphic User Interface.
RAID width, RAID copy, RAID row (RAID cell in one row)	RAID width, copy and row are used to describe one RG. E.g.: <ol style="list-style-type: none"> 1. One 4-disk RAID 0 volume: RAID width= 4; RAID copy=1; RAID row=1. 2. One 3-way mirroring volume: RAID width=1; RAID copy=3; RAID row=1. 3. One RAID 10 volume over 3 4-disk RAID 1 volume: RAID width=1; RAID copy=4; RAID row=3.
WT	Write-Through cache-write policy. A caching technique in which the completion of a write request is not signaled until data is safely stored in non-volatile media. Each data is synchronized in both data cache and accessed physical disks.
WB	Write-Back cache-write policy. A caching technique in which the completion of a write request is signaled as soon as the data is in cache and actual writing to non-volatile media occurs at a later time. It speeds up system write performance but needs to bear the risk where data may be inconsistent between data cache and the physical disks in one short time interval.
RO	Set the volume to be Read-Only .
DS	Dedicated Spare disks. The spare disks are only used by one specific RG. Others could not use these dedicated spare disks for any rebuilding purpose.
GS	Global Spare disks. GS is shared for rebuilding purpose. If some RGs need to use the global spare disks for rebuilding, they could get the spare disks out from the common spare disks pool for such requirement.
DC	Dedicated Cache.
GC	Global Cache.

DG	DeGraded mode. Not all of the array's member disks are functioning, but the array is able to respond to application read and write requests to its virtual disks.
SCSI	Small Computer Systems Interface.
SAS	Serial Attached SCSI.
iSCSI	Internet Small Computer Systems Interface.
SAS	Serial Attached SCSI.
FC	Fibre Channel.
S.M.A.R.T.	Self-Monitoring Analysis and Reporting Technology.
WWN	World Wide Name.
HBA	Host Bus Adapter.
SAF-TE	SCSI Accessed Fault-Tolerant Enclosures.
SES	SCSI Enclosure Services.
NIC	Network Interface Card.
LACP	Link Aggregation Control Protocol.
MPIO	Multi-Path Input/Output.
MC/S	Multiple Connections per Session
MTU	Maximum Transmission Unit.
CHAP	Challenge Handshake Authentication Protocol. An optional security mechanism to control access to an iSCSI storage system over the iSCSI data ports.
iSNS	Internet Storage Name Service.

1.3 RAID levels

RAID 0	Disk striping. RAID 0 needs at least one hard drive.
RAID 1	Disk mirroring over two disks. RAID 1 needs at least two hard drives.
N-way mirror	Extension to RAID 1 level. It has N copies of the disk.
RAID 3	Striping with parity on the dedicated disk. RAID 3 needs at least three hard drives.
RAID 5	Striping with interspersed parity over the member disks. RAID 3 needs at least three hard drives.
RAID 6	2-dimensional parity protection over the member disks. RAID 6 needs at least four hard drives.
RAID 0+1	Mirroring of the member RAID 0 volumes. RAID 0+1 needs at least four hard drives.
RAID 10	Striping over the member RAID 1 volumes. RAID 10 needs at least four hard drives.
RAID 30	Striping over the member RAID 3 volumes. RAID 30 needs at least six hard drives.
RAID 50	Striping over the member RAID 5 volumes. RAID 50 needs at least six hard drives.
RAID 60	Striping over the member RAID 6 volumes. RAID 60 needs at least eight hard drives.
JBOD	The abbreviation of “ J ust a B unch O f D isks”. JBOD needs at least one hard drive.

1.4 Volume relationship diagram

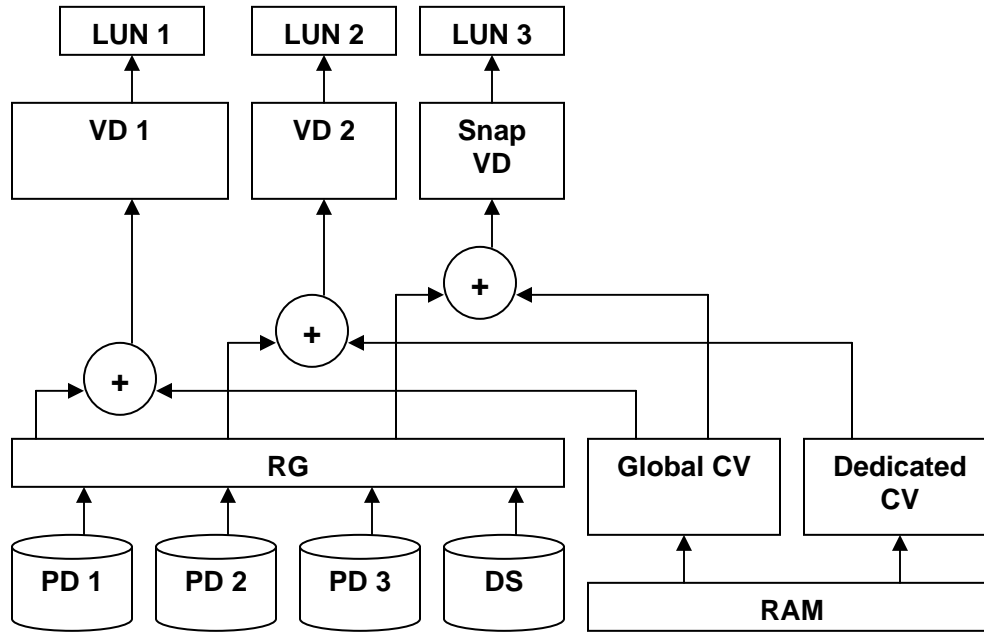

Figure 1.4.1

This is the volume structure of **ULTRASTOR** designed. It describes the relationship of RAID components. One RG (RAID group) consists of a set of VDs (Virtual disk) and owns one RAID level attribute. Each RG can be divided into several VDs. The VDs in one RG share the same RAID level, but may have different volume capacity. Each VD will be associated with one specific CV (Cache Volume) to execute the data transaction. Each CV can have different cache memory size by user's modification/setting. LUN (Logical Unit Number) is a unique identifier, in which users can access through SCSI commands.

Chapter 2 Getting started

2.1 Before starting

Before starting, prepare the following items.

1. Check “**Certification list**” in Appendix A to confirm the hardware setting is fully supported.
2. Read the latest release note before upgrading. Release note accompany with firmware.
3. A server with a FC HBA.
4. FC cables.
5. CAT 5e, or CAT 6 network cables for management port.
6. Prepare storage system configuration plan.
7. Management port network information. When using static IP, please prepare static IP addresses, subnet mask, and default gateway.
8. Setup the hardware connection before power on servers and **ULTRASTOR** controllers. Connect FC cables, console cable, and management port cable in advance.

2.2 Storage introduction

RS16FS is a fibre channel network technology primarily used for storage network. It started use primarily in the supercomputer field, but has become the standard connection type for storage area networks (SAN) in enterprise storage.

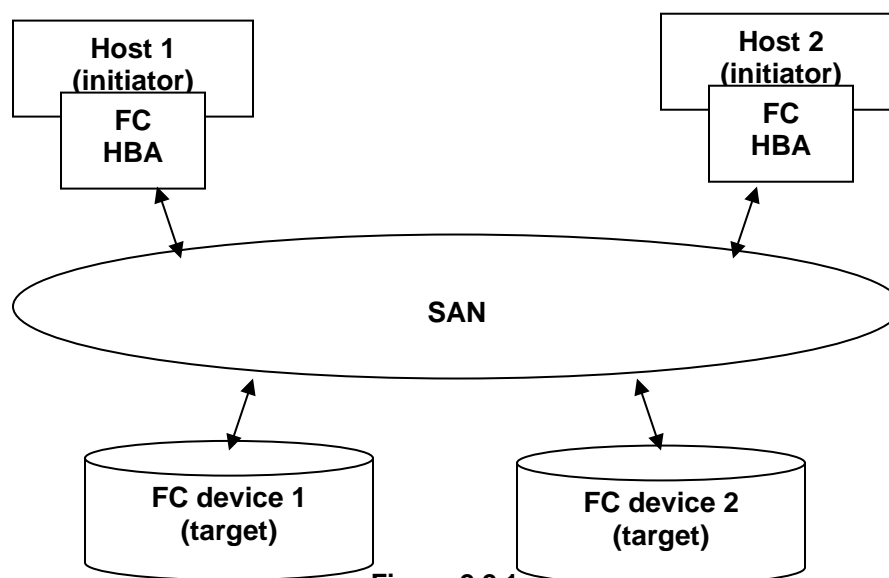

Figure 2.2.1

The target is the storage device itself or an appliance which controls and serves volumes or virtual volumes. The target is the device which performs SCSI commands or bridges to an attached storage device.

2.3 Management methods

There are three management methods to manage **ULTRASTOR RS16 FS** controller, describe in the following:

2.3.1 Web GUI

RS16FS controllers support graphic user interface to manage the system. Be sure to connect LAN cable. The default setting of management port IP is DHCP and DHCP address displays on LCM; user can inspect LCM for IP first, then open the browser and type the DHCP address: (The DHCP address is dynamic and user may need to check every time after reboot.) When DHCP service is not available, controllers use zero configuration (Zeroconf) to get an IP address.

Take an example on LCM:

192.168.10.50 UltrasStor RS16 F ←

http://192.168.10.50

or

https://192.168.10.50 (https: connection with encrypted Secure Sockets Layer (SSL). Please be aware of the https is slower than http. https is supported on some specified models.)

Click any function at the first time; it will pop up a dialog to authenticate current user.

Login name: **admin**

Default password: **1234**

Or login with read-only account which only allows reading the configuration and cannot change setting.

Login name: **user**

Default password: **1234**

2.3.2 Console serial port

Use NULL modem cable to connect console port.

The console setting is baud rate: **115200**, 8 bits, 1 stop bit, and no parity.

Terminal type: **vt100**

Login name: **admin**

Default password: **1234**

2.3.3 Remote control – secure shell

SSH (secure shell) is required for controllers to remote login. The SSH client software is available at the following web site:

SSHWinClient WWW: <http://www.ssh.com/>

Putty WWW: <http://www.chiark.greenend.org.uk/>

Host name: **192.168.10.50** (Please check your DHCP address for this field.)

Login name: **admin**

Default password: **1234**



Tips

ULTRASTOR RS16 FC controllers only support SSH for remote control. For using SSH, the IP address and password are required for login.

2.4 Enclosure

2.4.1 LCM

There are four buttons to control **RS16FSLCM** (LCD Control Module), including:

▲ (up), ▼ (down), **ESC** (Escape), and **ENT** (Enter).

After booting up the system, the following screen shows management port IP and model name:

```
192.168.10.50
RS16FS←←
```

Press “**ENT**”, the LCM functions “**System Info.**”, “**Alarm Mute**”, “**Reset/Shutdown**”, “**Quick Install**”, “**Volume Wizard**”, “**View IP Setting**”,

“Change IP Config” and “Reset to Default” will rotate by pressing ▲ (up) and ▼ (down).

When there is WARNING or ERROR occurred (LCM default filter), the LCM shows the event log to give users more detail from front panel.

The following table is function description.

System Info.	Display system information.
Alarm Mute	Mute alarm when error occurs.
Reset/Shutdown	Reset or shutdown controller.
Quick Install	Quick steps to create a volume. Please refer to next chapter for operation in web UI.
Volume Wizard	Smart steps to create a volume. Please refer to next chapter for operation in web UI.
View IP Setting	Display current IP address, subnet mask, and gateway.
Change IP Config	Set IP address, subnet mask, and gateway. There are 2 options: DHCP (Get IP address from DHCP server) or static IP.
Reset to Default	Reset to default will set password to default: 1234 , and set IP address to default as DHCP setting. Default IP address: 192.168.10.50 (DHCP) Default subnet mask: 255.255.255.0 Default gateway: 192.168.10.254

The following is LCM menu hierarchy.

Proavio, U.S.A. ▲▼	[System Info.]	[Firmware Version x.x.x]			
		[RAM Size xxx MB]			
	[Alarm Mute]	[▲Yes No▼]			
	[Reset/Shutdown]	[Reset]	[▲Yes No▼]		
		[Shutdown]	[▲Yes No▼]		

	[Quick Install]	RAID 0 RAID 1 RAID 3 RAID 5 RAID 6 RAID 0+1 xxx GB	[Apply The Config]	[▲Yes No▼]	
	[Volume Wizard]	[Local] RAID 0 RAID 1 RAID 3 RAID 5 RAID 6 RAID 0+1	[Use default algorithm]	[Volume Size] xxx GB	[Apply The Config] [▲Yes No▼]
		[JBOD x] ▲▼ RAID 0 RAID 1 RAID 3 RAID 5 RAID 6 RAID 0+1	[new x disk] ▲▼ xxx GB	Adjust Volume Size	[Apply The Config] [▲Yes No▼]
	[View IP Setting]	[IP Config] [Static IP]			
		[IP Address] [192.168.010.050]			
		[IP Subnet Mask] [255.255.255.0]			
		[IP Gateway] [192.168.010.254]			
	[Change IP Config]	[DHCP]	[▲Yes No▼]		
		[Static IP]	[IP Address]	Adjust IP address	
			[IP Subnet Mask]	Adjust Submask IP	
			[IP Gateway]	Adjust Gateway IP	
			[Apply IP Setting]	[▲Yes No▼]	
	[Reset to Default]	[▲Yes No▼]			



Caution
Before power off, it is better to execute “**Shutdown**” to flush the data from cache to physical disks.

2.4.2 System buzzer

The system buzzer features are listed below:

1. The system buzzer alarms 1 second when system boots up successfully.
2. The system buzzer alarms continuously when there is error occurred. The alarm will be stopped after error resolved or be muted.
3. The alarm will be muted automatically when the error is resolved. E.g., when RAID 5 is degraded and alarm rings immediately, user changes/adds one physical disk for rebuilding. When the rebuilding is done, the alarm will be muted automatically.

2.4.3 LED

The LED features are listed below:

1. **Marquee / Disk Status / Disk Rebuilding LED:** The Marquee / Disk Status / Disk Rebuilding LEDs are displayed in the same LEDs. The LEDs indicates different functions in different stages.
 - I. **Marquee LEDs:** When system powers on and successfully boots up, the Marquee LED is on until the system boots successful.
 - II. **Disk status LEDs:** the LEDs reflect the disk status for the tray. Only On/Off situation.
 - III. **Disk rebuilding LEDs:** the LEDs are blinking when the disks are under rebuilding.
2. **Disk Access LED:** Hardware activated LED when accessing disks (IO).
3. **Disk Power LED:** Hardware activated LED when the disks are plugged in and powered on.
4. **System status LED:** Used to reflect the system status by turning on the LED when error occurs or RAID malfunction happens.
5. **Management LAN port LED:** GREEN LED is for LAN transmit/receive indication. ORANGE LED is for LAN port 10/100 LINK indication.
6. **BUSY LED:** Hardware activated LED when the front-end channel is busy.
7. **POWER LED:** Hardware activated LED when system is powered on.

Chapter 3 Web GUI guideline

3.1 Web GUI hierarchy

The below table is the hierarchy of web GUI.

Quick installation	→ Step 1 / Step 2 / Confirm
System configuration	
System setting	→ System name / Date and time
IP address	→ MAC address / Address / DNS / port
Login setting	→ Login configuration / Admin password / User password
Mail setting	→ Mail
Notification setting	→ SNMP / Messenger / System log server / Event log filter
Volume configuration	
Volume create wizard	Step 1 / Step 2 / Step 3 / Step 4 / Confirm
Physical disk	→ Set Free disk / Set Global spare / Set Dedicated spare / Set property / More information
RAID group	→ Create / Migrate / Activate / Deactivate / Scrub / Delete / Set disk property / More information
Virtual disk	→ Create / Extend / Scrub / Delete / Set property / Attach LUN / Detach LUN / List LUN / Set snapshot space / Cleanup snapshot / Take snapshot / Auto snapshot / List snapshot / More information
Snapshot	→ Cleanup snapshot / Auto snapshot / Take snapshot / Export / Rollback / Delete
Logical unit	→ Attach / Detach
Enclosure management	
SES configuration	→ Enable / Disable
Hardware monitor	→ Auto shutdown
S.M.A.R.T.	→ S.M.A.R.T. information (Only for SATA disks)
UPS	→ UPS Type / Shutdown battery level / Shutdown delay / Shutdown UPS
Maintenance	
System information	→ System information
Upgrade	→ Browse the firmware to upgrade / Export configuration
Reset to default	→ Sure to reset to factory default?
Import and export	→ Import/Export / Import file
Event log	→ Download / Mute / Clear

Reboot and shutdown → Reboot / Shutdown

Logout

Sure to logout?

3.2 Login

ULTRASTOR RS16 FS controller supports graphic user interface (GUI) to operate the system. Be sure to connect the LAN cable. The default IP setting is **DHCP**; open the browser and enter:

http://192.168.10.50 (Please check the DHCP address first on LCM.)

Click any function at the first time; it will pop up a dialog for authentication.

Login name: **admin**

Default password: **1234**

After login, you can choose the functions which lists on the left side of window to make configuration.

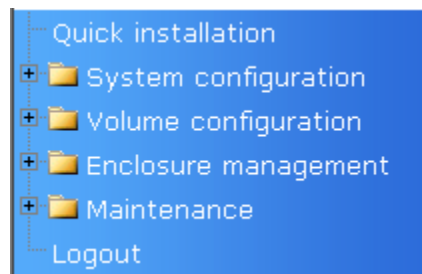







Figure 3.2.1

There are six indicators at the top-right corner for backplane solutions, and cabling solutions have three indicators at the top-right corner.



Figure 3.2.2

1.  **RAID light:** Green means RAID works well. Red represents RAID failure.
2.  **Temperature light:** Green means normal temperature. Red represents abnormal temperature.

3.  **Voltage light:** Green means normal voltage. Red represents abnormal voltage..
4.  **UPS light:** Green means UPS works well. Red represents UPS failure.
5.  **Fan light:** Green means Fan works well. Red represents fan failure. **(Only for backplane solution)**
6.  **Power light:** Green means Power works well. Red represents power failure. **(Only for backplane solution)**

3.3 Quick install

It is easy to use “**Quick install**” to create a volume. It uses whole physical disks to create a RG; the system will calculate maximum spaces on RAID levels 0/1/3/5/6/0+1. “**Quick install**” will occupy all residual RG space for one VD, and it has no space for snapshot and spare. If snapshot is needed, please create volumes by manual, and refer to section 4.4 for more detail. If some physical disks are used in other RGs, “**Quick install**” can not be run because the operation is valid only when all physical disks in this system are free.

Step 1: Click “**Quick install**”, then choose the RAID level. After choosing the RAID level, then click “  ”. It will link to another page.

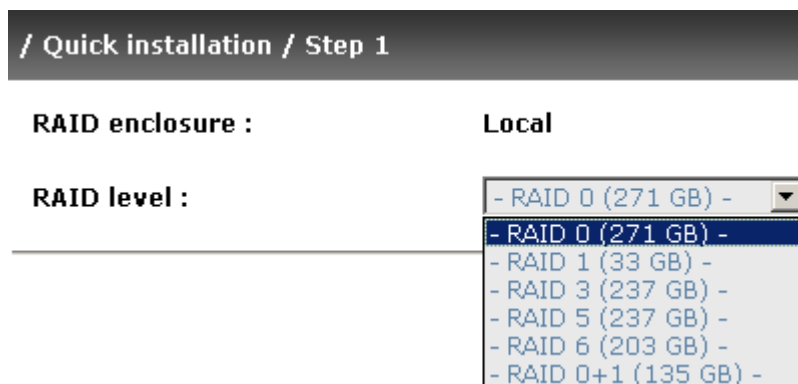



Figure 3.3.1

Step 2: Confirm page. Click “  ” if all setups are correct. Then a VD will be created.

Done. You can start to use the system now.

No.	Name	Size (GB)	Right	Priority	Bg rate	Status	Health	R %	RAID	#LUN	Snapshot (MB)	#Snapshot	RG name
1	QUICK11862	271	WB	HI	4	Online	Optimal		RAID 0	1	0/0	0	QUICK16150



Figure 3.3.2

(Figure 3.3.2: A RAID 0 Virtual disk with the VD name “QUICK16150”, named by system itself, with the total available volume size 271GB.)

3.4 System configuration

“System configuration” is designed for setting up the “System setting”, “IP address”, “Login setting”, “Mail setting”, and “Notification setting”.

System setting	System name for identification System time for event log
IP address	Internet Protocol(IP) address for remote administration
Login setting	Configuration for auto logout and login lock Administrator's password
Mail setting	Alert by e-mail
Notification setting	Alert via Simple Network Management Protocol(SNMP) Transmits net send and alerter service messages between clients and servers Alert to remote system log server

Figure 3.4.1

3.4.1 System setting

“**System setting**” can set system name and date. Default “**System name**” composed of model name and serial number of this system.

System name

System name : F200C-a00001

Date and time

Change date and time

Current time : 2008/5/7 11:14:58

Time zone : (GMT+08:00) Taipei

Setup date and time manually

Date : 2008 / 5 / 7

Time : 11 : 14 : 38

NTP

Server :

Figure 3.4.1.1

Check “**Change date and time**” to set up the current date, time, and time zone before using or synchronize time from NTP (Network Time Protocol) server.

3.4.2 IP address

“**IP address**” can change IP address for remote administration usage. There are 2 options, DHCP (Get IP address from DHCP server) or static IP. The default setting is DHCP. User can change the HTTP, HTTPS, and SSH port number when the default port number is not allowed on host/server.

MAC address	
MAC address :	00:13:78:AC:00:19

Address	
<input checked="" type="radio"/>	DHCP
<input type="radio"/>	Static
Address :	<input type="text"/>
Mask :	<input type="text"/>
Gateway :	<input type="text"/>

DNS	
DNS :	<input type="text"/>

Port	
HTTP port :	<input type="text" value="80"/>
HTTPS port :	<input type="text" value="443"/>
SSH port :	<input type="text" value="22"/>

Figure 3.4.2.1

3.4.3 Login setting

“**Login setting**” can set single admin, auto logout time and Admin/User password. The single admin can prevent multiple users access the same controller at the same time.

1. **Auto logout:** The options are (1) Disable; (2) 5 minutes; (3) 30 minutes; (4) 1 hour. The system will log out automatically when user is inactive for a period of time.
2. **Login lock:** Disable/Enable. When the login lock is enabled, the system allows only one user to login or modify system settings.

Login configuration	
Auto logout :	- Disable - ▾
Login lock :	- Disable - ▾
Admin password	
<input type="checkbox"/> Change admin password	
Old password :	<input type="password"/>
Password :	<input type="password"/>
Confirm :	<input type="password"/>
User password	
<input type="checkbox"/> Change user password	
Password :	<input type="password"/>
Confirm :	<input type="password"/>

Figure 3.4.3.1

Check “**Change admin password**” or “**Change user password**” to change admin or user password. The maximum length of password is 12 characters.

3.4.4 Mail setting

“**Mail setting**” can enter at most 3 mail addresses for receiving the event notification. Some mail servers would check “**Mail-from address**” and need authentication for anti-spam. Please fill the necessary fields and click “**Send test mail**” to test whether email functions are available. User can also select which levels of event logs are needed to be sent via Mail. Default setting only enables ERROR and WARNING event logs.

Mail

Mail-from address :

Mail-to address 1 :

Send events 1 : INFO WARNING ERROR

Mail-to address 2 :

Send events 2 : INFO WARNING ERROR

Mail-to address 3 :

Send events 3 : INFO WARNING ERROR

SMTP relay

SMTP server :

Authentication :

Account :

Password :

Confirm :

Figure 3.4.4.1

3.4.5 Notification setting

“**Notification setting**” can set up SNMP trap for alerting via SNMP, pop-up message via Windows messenger (not MSN), alert via syslog protocol, and event log filter.

SNMP	
SNMP trap address 1 :	<input type="text"/>
SNMP trap address 2 :	<input type="text"/>
SNMP trap address 3 :	<input type="text"/>
Community :	public <input type="text"/>
Send events :	<input checked="" type="checkbox"/> INFO <input checked="" type="checkbox"/> WARNING <input checked="" type="checkbox"/> ERROR
Messenger	
Messenger IP/Computer name 1 :	<input type="text"/>
Messenger IP/Computer name 2 :	<input type="text"/>
Messenger IP/Computer name 3 :	<input type="text"/>
Send events :	<input checked="" type="checkbox"/> INFO <input checked="" type="checkbox"/> WARNING <input checked="" type="checkbox"/> ERROR
System log server	
Server IP/hostname :	<input type="text"/>
UDP Port :	514 <input type="text"/>
Facility :	Local0 <input type="text"/>
Event level :	<input checked="" type="checkbox"/> INFO <input checked="" type="checkbox"/> WARNING <input checked="" type="checkbox"/> ERROR
Event log filter	
Pop up events :	<input type="checkbox"/> INFO <input type="checkbox"/> WARNING <input type="checkbox"/> ERROR
Show on LCM :	<input type="checkbox"/> INFO <input checked="" type="checkbox"/> WARNING <input checked="" type="checkbox"/> ERROR

Figure 3.4.5.1

“**SNMP**” allows up to 3 SNMP trap addresses. Default community setting is “public”. User can choose the event log levels and default setting only enables INFO event log in SNMP. There are many SNMP tools. The following web sites are for your reference:

SNMPc: <http://www.snmpc.com/>

Net-SNMP: <http://net-snmp.sourceforge.net/>

Using “**Messenger**”, user must enable the service “Messenger” in Windows (Start → Control Panel → Administrative Tools → Services → Messenger), and then event logs can be received. It allows up to 3 messenger addresses. User can choose the event log levels and default setting enables the WARNING and ERROR event logs.

Using “**System log server**”, user can choose the facility and the event log level. The default port of syslog is 514. The default setting enables event level: INFO, WARNING and ERROR event logs.

There are some syslog server tools. The following web sites are for your reference:

WinSyslog: <http://www.winsyslog.com/>

Kiwi Syslog Daemon: <http://www.kiwisyslog.com/>

Most UNIX systems build in syslog daemon.

“**Event log filter**” setting can enable event level on “Pop up events” and “LCM”.

3.5 Volume configuration

“**Volume configuration**” is designed for setting up the volume configuration which includes “**Volume create wizard**”, “**Physical disk**”, “**RAID group**”, “**Virtual disk**”, “**Snapshot**”, and “**Logical unit**”.

Volume create wizard	Easy and quick step-by-step volume configuration
Physical disk	Hard disks to store data
RAID group	Sets of physical disks with RAID functions
Virtual disk	Slices of RAID groups
Snapshot	Point-in-time copies of the data
Logical unit	Target volumes for hosts access

Figure 3.5.1

3.5.1 Volume create wizard

“**Volume create wizard**” has a smarter policy. When the system is inserted with some HDDs. “Volume create wizard” lists all possibilities and sizes in different RAID levels, it will use all available HDDs for RAID level depends on which user chooses. When system has different sizes of HDDs, e.g., 8*200G and 8*80G, it lists all possibilities and combination in different RAID level and different sizes. After user chooses RAID level, user may find that some HDDs are available (free status). The result is using smarter policy designed by **Proavio, U.S.A.**. It gives user:

1. Biggest capacity of RAID level for user to choose and,
2. The fewest disk number for RAID level / volume size.

E.g., user chooses RAID 5 and the controller has 12*200G + 4*80G HDDs inserted. If we use all 16 HDDs for a RAID 5, and then the maximum size of volume is 1200G (80G*15). By the wizard, we do smarter check and find out the most efficient way of using HDDs. The wizard only uses 200G HDDs (Volume size is 200G*11=2200G), the volume size is bigger and fully uses HDD capacity.

Step 1: Select “**Volume create wizard**” and then choose the RAID level. After the RAID level is chosen, click “  ”. Then it will link to next page.

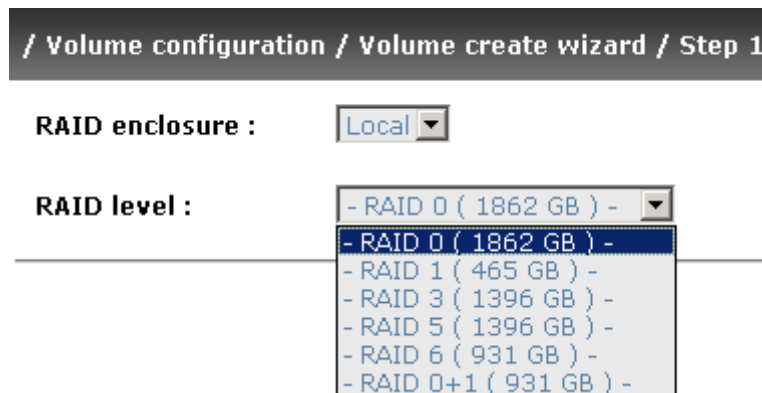



Figure 3.5.1.1

Step 2: Please select the combination of the RG capacity, or “**Use default algorithm**” for maximum RG capacity. After RG size is chosen, click “  ”.

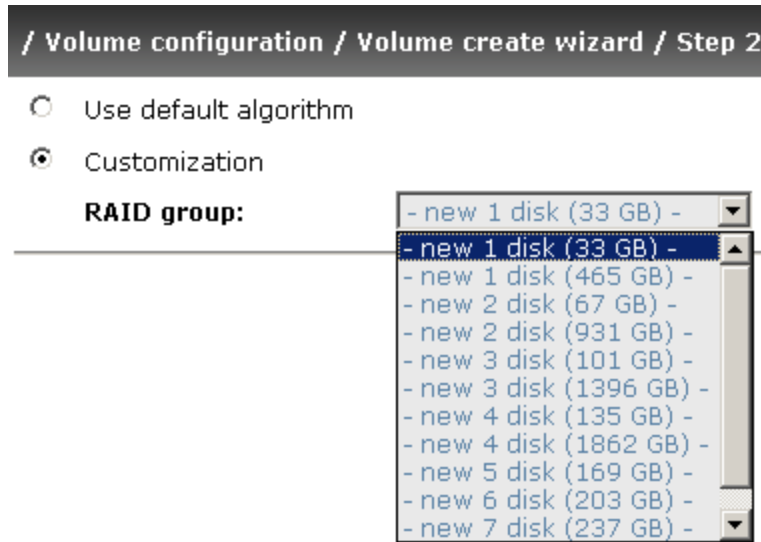

Figure 3.5.1.2

Step 3: Decide VD size. User can enter a number less or equal to the default number. Then click “ ”.

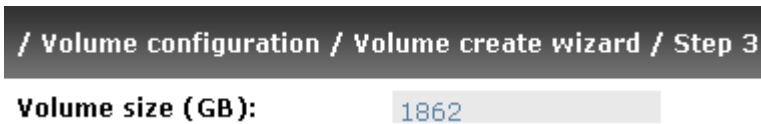

Figure 3.5.1.3

Step 4: Confirm page. Click “ ” if all setups are correct. Then a VD will be created.

Done. You can start to use the system now.

No.	Name	Size (GB)	Right	Priority	Bg rate	Status	Health	R %	RAID	#LUN	Snapshot (MB)	#Snapshot	RG name
1	QUICK14274	1862	WB	HI	4	Online	Optimal		RAID 0	1	0/0	0	QUICK13573

Figure 3.5.1.4

(Figure 3.5.1.4: A RAID 0 Virtual disk with the VD name “QUICK13573”, named by system itself, with the total available volume size 1862GB.)

3.5.2 Physical disk

“Physical disk” can view the status of hard drives in the system. The followings are operational tips:

1. Mouse moves to the gray button next to the number of slot, it will show the functions which can be executed.
2. Active function can be selected, but inactive function will show in gray color.

For example, set PD slot number 11 to dedicated spare disk.

Step 1: Mouse moves to the gray button of PD 11, select “Set Dedicated spare”, it will link to next page.

11	74		Online	Good	FR	SAMSUNG	S01UJ20Y297150	SATA	Enabled	Disabled
Set Free disk			line	Good	FR	Seagate	5JVD1GVG	SATA	Enabled	Disabled
Set Global spare			line	Good	FR	SAMSUNG	S01UJ10Y300998	SATA	Enabled	Disabled
Set Dedicated spare			line	Good	FR	Seagate	5JVD1GT5	SATA	Enabled	Disabled
Set property										
More information			line	Good	FR	Seagate	5JVD1GT5	SATA	Enabled	Disabled

Figure 3.5.2.1

Step 2: Maybe it has some RGs which can be set dedicate spare disk, select which one will be added, then click “Confirm”.

Available VG for slot 4 on Local :

	No.	Name	Total (GB)	Free (GB)	#PD	#VD	Status	Health	RAID	Enclosure
⊙	1	RG-R5	931	931	3	0	Online	Good	RAID 5	Local

Figure 3.5.2.2

Done. View “Physical disk” page.

Local

Slot	Size (GB)	RG name	Status	Health	Usage	Vendor	Serial	Type	Write cache	Standby
1	465	RG-R5	Online	Good	RD	Maxtor	H80DMBPH	SATA2	Enabled	Disabled
2	465	RG-R5	Online	Good	RD	Maxtor	H81173QH	SATA2	Enabled	Disabled
3	465	RG-R5	Online	Good	RD	Seagate	3PM0H4C0	SATA2	Enabled	Disabled
4	465	RG-R5	Online	Good	DS	Seagate	3PM0FRH7	SATA2	Enabled	Disabled
5	33		Online	Good	FR	HITACHI	J3XADKPJ	SAS	Enabled	Disabled
6	33		Online	Good	FR	HITACHI	J3XAB71J	SAS	Enabled	Disabled
7	33		Online	Good	FR	HITACHI	J3XAE5MJ	SAS	Enabled	Disabled
8	33		Online	Good	FR	HITACHI	J3XAAYRJ	SAS	Enabled	Disabled

Figure 3.5.2.3

(Figure 3.5.2.3: Physical disks of slot 1,2,3 are created for a RG named “RG-R5”. Slot 4 is set as dedicated spare disk of RG named “RG-R6”. The others are free disks.)

- **PD column description:**

Slot	The position of hard drives. The button next to the number of slot shows the functions which can be executed.
Size (GB)	Capacity of hard drive.
RG Name	Related RAID group name.
Status	The status of hard drive. “Online” → the hard drive is online. “Rebuilding” → the hard drive is being rebuilt. “Transition” → the hard drive is being migrated or is replaced by another disk when rebuilding occurs. “Missing” → the hard drive has already joined a RG but not plugged into the disk tray of current system.
Health	The health of hard drive. “Good” → the hard drive is good.

	<p>“Failed” → the hard drive is failed.</p> <p>“Error Alert” → S.M.A.R.T. error alert.</p> <p>“Read Errors” → the hard drive has unrecoverable read errors.</p>
Usage	<p>“RD” → RAID Disk. This hard drive has been set to RAID.</p> <p>“FR” → FRee disk. This hard drive is free for use.</p> <p>“DS” → Dedicated Spare. This hard drive has been set to the dedicated spare of the RG.</p> <p>“GS” → Global Spare. This hard drive has been set to a global spare of all RGs.</p> <p>“RS” → ReServe. The hard drive contains the RG information but cannot be used. It may be caused by an uncompleted RG set, or hot-plug of this disk in the running time. In order to protect the data in the disk, the status changes to reserve. It can be reused after setting it to “FR” manually.</p>
Vendor	Hard drive vendor.
Serial	Hard drive serial number.
Type	<p>Hard drive type.</p> <p>“SATA” → SATA disk.</p> <p>“SATA2” → SATA II disk.</p> <p>“SAS” → SAS disk.</p>
Write cache	Hard drive write cache is enabled or disabled.
Standby	HDD auto spindown to save power. The default value is disabled.

- **PD operations description:**

Set Free disk	Make the selected hard drive to be free for use.
Set Global spare	Set the selected hard drive to global spare of all RGs.

Set Dedicated spares	Set hard drive to dedicated spare of selected RGs.
Set property	Change the status of write cache and standby. Write cache options: “ Enabled ” → Enable disk write cache. “ Disabled ” → Disable disk write cache. Standby options: “ Disabled ” → Disable spindown. “ 30 sec / 1 min / 5 min / 30 min ” → Enable hard drive auto spindown to save power in the period of time.
More information	Show hard drive detail information.

3.5.3 RAID group

“RAID group” can view the status of each RAID group. The following is an example to create a RG.

Step 1: Click “ ”, enter “Name”, choose “RAID level”, click “ ” to select PD. Then click “ ”.

/ Volume configuration / RAID group / Create
 Name :
 RAID level :
 RAID PD slot :
 Write Cache :
 Standby :
 Disabled
 30 sec
 1 min
 5 min
 30 min

Figure 3.5.3.1

Step 2: Confirm page. Click “  ” if all setups are correct.

No.	Name	Total (GB)	Free (GB)	#PD	#VD	Status	Health	RAID	Enclosure
1	RG-R0	135	135	4	0	Online	Good	RAID 0	Local
2	RG-R5	931	931	3	0	Online	Good	RAID 5	Local

Migrate	Activate	Deactivate	Scrub	Delete	Set disk property	More information	
---------	----------	------------	-------	--------	-------------------	------------------	---

Figure 3.5.3.2

(Figure 3.5.3.2: There is a RAID 0 with 4 physical disks, named “RG-R0”, total size is 135GB. Another is a RAID 5 with 3 physical disks, named “RG-R5”.)

Done. View “RAID group” page.

- **RG column description:**

No.	Number of RAID group. The button next to the No. shows the functions which can be executed.
Name	RAID group name.
Total(GB)	Total capacity of this RAID group.
Free(GB)	Free capacity of this RAID group.
#PD	The number of physical disks in RAID group.
#VD	The number of Virtual disks in RAID group.
Status	The status of RAID group. “Online” → the RAID group is online. “Offline” → the RAID group is offline.

	<p>“Rebuild” → the RAID group is being rebuilt.</p> <p>“Migrate” → the RAID group is being migrated.</p> <p>“Scrub” → the RAID group is being scrubbed.</p>
Health	<p>The health of RAID group.</p> <p>“Good” → the RAID group is good.</p> <p>“Failed” → the hard drive is failed.</p> <p>“Degraded” → the RAID group is not completed. The reason could be lack of one disk or disk failure.</p>
RAID	The RAID level of the RAID group.
Enclosure	RG locates on local or JBOD enclosure.

- **RG operations description:**

Create	Create a RAID group.
Migrate	Migrate a RAID group. Please refer to next chapter for more detail.
Activate	Activate a RAID group; it can be executed when RG status is offline. This is for online roaming purpose.
Deactivate	Deactivate a RAID group; it can be executed when RG status is online. This is for online roaming purpose.
Scrub	Scrub a RAID group. It's a parity regeneration. It supports RAID 3 / 5 / 6 / 30 / 50 / 60 only.
Delete	Delete a RAID group.
Set disk property	<p>Change the disk status of write cache and standby.</p> <p>Write cache options:</p> <p>“Enabled” → Enable disk write cache.</p> <p>“Disabled” → Disable disk write cache.</p> <p>Standby options:</p> <p>“Disabled” → Disable spindown.</p> <p>“30 sec / 1 min / 5 min / 30 min” → Enable hard drive auto spindown to save power in the period of time.</p>

More information	Show RAID group detail information.
-------------------------	-------------------------------------

3.5.4 Virtual disk

“**Virtual disk**” can view the status of each Virtual disk. The following is an example to create a VD.

Step 1: Click “ ”, enter “**Name**”, choose “**RG name**”, “**Stripe height (KB)**”, “**Block size (B)**”, “**Read/Write**” mode, “**Priority**”, “**Bg rate**” (Background task priority), change “**Capacity (GB)**” if necessary. Then click “ ”.

/ Volume configuration / Virtual disk / Create

Name :	<input type="text" value="VD-01"/>
RG name :	<input type="text" value="RG-R0"/>
Capacity (GB) :	<input type="text" value="30"/>
Stripe height (KB) :	<input type="text" value="64"/>
Block size (B) :	<input type="text" value="512"/>
Read/Write :	<input type="radio"/> Write-through cache <input checked="" type="radio"/> Write-back cache
Priority :	<input checked="" type="radio"/> High priority <input type="radio"/> Middle priority <input type="radio"/> Low priority
Bg rate :	<input type="text" value="4"/>

Figure 3.5.4.1

Step 2: Confirm page. Click “ ” if all setups are correct.

No.	Name	Size (GB)	Right	Priority	Bg rate	Status	Health	R %	RAID	#LUN	Snapshot (MB)	#Snapshot	RG name
1	VD-01	30	WB	HI	4	Online	Optimal		RAID 0	0	0/0	0	RG-R0
2	VD-02	20	WB	HI	4	Initiating	Optimal	12	RAID 5	0	0/0	0	RG-R5

- Extend
- Scrub
- Delete
- Set property
- Attach LUN
- Detach LUN
- List LUN
- Set snapshot space
- Cleanup snapshot
- Take snapshot
- Auto snapshot
- List snapshot
- More information

Figure 3.5.4.2

(Figure 3.5.4.2: Create a VD named “VD-01”, related to “RG-R0”, size is 30GB. The other VD is named “VD-02”, initializing to 12%.)

Done. View “Virtual disk” page.

- **VD column description:**

No.	Number of this Virtual disk. The button next to the VD No. shows the functions which can be executed.
Name	Virtual disk name.
Size(GB)	Total capacity of the Virtual disk.
Right	<p>“WT” → Write Through.</p> <p>“WB” → Write Back.</p> <p>“RO” → Read Only.</p>
Priority	<p>“HI” → High priority.</p> <p>“MD” → MiD priority.</p> <p>“LO” → Low priority.</p>

Bg rate	Background task priority. “ 4 / 3 / 2 / 1 / 0 ” → Default value is 4. The higher number the background priority of a VD has, the more background I/O will be scheduled to execute.
Status	The status of Virtual disk. “ Online ” → the Virtual disk is online. “ Offline ” → the Virtual disk is offline. “ Initiating ” → the Virtual disk is being initialized. “ Rebuild ” → the Virtual disk is being rebuilt. “ Migrate ” → the Virtual disk is being migrated. “ Rollback ” → the Virtual disk is being rolled back. “ Scrub ” → the Virtual disk is being scrubbed.
Health	The health of Virtual disk. “ Optimal ” → the Virtual disk is operating and has experienced no failures of the disks that comprise the RG. “ Degraded ” → At least one disk which comprises space of the Virtual disk has been marked as failed or has been plugged. “ Missing ” → the Virtual disk has been marked as missing by the system. “ Failed ” → the Virtual disk has experienced enough failures of the disks that comprise the VD for unrecoverable data loss to occur. “ Part optimal ” → the Virtual disk has experienced disk failures.
R %	Ratio of initializing or rebuilding.
RAID	The levels of RAID that Virtual disk is using.
#LUN	Number of LUN(s) that Virtual disk is attaching.
Snapshot (MB)	The Virtual disk size that used for snapshot. The number means “ Used snapshot space ” / “ Total snapshot space ”. The unit is in megabytes (MB).

#Snapshot	Number of snapshot(s) that Virtual disk is taken.
RG name	The Virtual disk is related to the RG name

- **VD operations description:**

Extend	Extend a Virtual disk capacity.
Scrub	Scrub a Virtual disk. It's a parity regeneration. It supports RAID 3 / 5 / 6 / 30 / 50 / 60 only.
Delete	Delete a Virtual disk.
Set property	<p>Change the VD name, right, priority and bg rate.</p> <p>Right options:</p> <p> "WT" → Write Through.</p> <p> "WB" → Write Back.</p> <p> "RO" → Read Only.</p> <p>Priority options:</p> <p> "HI" → High priority.</p> <p> "MD" → MiD priority.</p> <p> "LO" → LOW priority.</p> <p>Bg rate options:</p> <p> "4 / 3 / 2 / 1 / 0" → Default value is 4. The higher number the background priority of a VD has, the more background I/O will be scheduled to execute.</p>
Attach LUN	Attach to a LUN.
Detach LUN	Detach to a LUN.
List LUN	List attached LUN(s).
Set snapshot space	Set snapshot space for executing snapshot. Please refer to next chapter for more detail.
Cleanup snapshot	Clean all snapshot VD related to the Virtual disk and release snapshot space.

Take snapshot	Take a snapshot on the Virtual disk.
Auto snapshot	Set auto snapshot on the Virtual disk.
List snapshot	List all snapshot VD related to the Virtual disk.
More information	Show Virtual disk detail information.

3.5.5 Snapshot

“**Snapshot**” can view the status of snapshot. Please refer to next chapter for more detail about snapshot concept. The following is an example to take a snapshot.

Step 1: Create snapshot space. In “/ **Volume configuration / Virtual disk**”, mouse moves to the gray button next to the VD number; click “**Set snapshot space**”.

Step 2: Set snapshot space. Then click “ ”. The snapshot space is created.

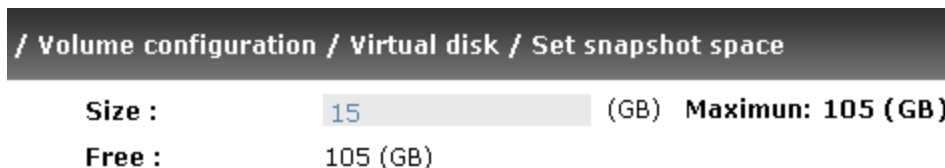

Figure 3.5.5.1

No.	Name	Size (GB)	Right	Priority	Bg rate	Status	Health	R %	RAID	#LUN	Snapshot (MB)	#Snapshot	RG name
1	VD-01	30	WB	HI	4	Online	Optimal		RAID 0	0	263/15360	0	RG-R0
2	VD-02	20	WB	HI	4	Online	Optimal		RAID 5	0	0/0	0	RG-R5

Figure 3.5.5.2

(Figure 3.5.5.2: “VD-01” snapshot space has been created, snapshot space is 15360MB, and used 425MB for saving snapshot index.)

Step 3: Take a snapshot. In “/ **Volume configuration / Snapshot**”, click “ ”. It will link to next page. Enter a snapshot name.

Linked snapshot for VD: -VD-01-

No.	Name	Used (MB)	Exported	Right	#LUN	Created time
1	SnapVD-01	0	No	N/A	N/A	Wed May 28 15:22:50 2008

Export
Rollback
Delete

<< Back Cleanup Auto snapshot Take snapshot

Figure 3.5.5.3

Step 4: Export the snapshot VD. Move the mouse to the gray button next to the Snapshot VD number; click **“Export”**. Enter a capacity for snapshot VD. If size is zero, the exported snapshot VD will be read only. Otherwise, the exported snapshot VD can be read / written, and the size will be the maximum capacity to read / write.

/ Volume configuration / Snapshot / Set quota

Size :

Available : 14 (GB)

Figure 3.5.5.4

Linked snapshot for VD: -VD-01-

No.	Name	Used (MB)	Exported	Right	#LUN	Created time
1	SnapVD-01	0	Yes	RO	0	Wed May 28 15:22:50 2008
2	SnapVD-02	0	Yes	RW	0	Wed May 28 15:26:40 2008

Unexport
Rollback
Delete
Attach
Detach
List LUN

<< Back Cleanup Auto snapshot Take snapshot

Figure 3.5.5.5

(Figure 3.5.5.5: This is the list of “VD-01”. There are two snapshots in “VD-01”. Snapshot VD “SnapVD-01” is exported to read only, “SnapVD-02” is exported to read/write.)

Step 5: Attach a LUN for snapshot VD. Please refer to the next section for attaching a LUN.

Done. Snapshot VD can be used.

- **Snapshot column description:**

No.	Number of this snapshot VD. The button next to the snapshot VD No. shows the functions which can be executed.
Name	Snapshot VD name.
Used (MB)	The amount of snapshot space that has been used.
Exported	Snapshot VD is exported or not.
Right	<p>“RW” → Read / Write. The snapshot VD can be read / write.</p> <p>“RO” → Read Only. The snapshot VD can be read only.</p>
#LUN	Number of LUN(s) that snapshot VD is attaching.
Created time	Snapshot VD created time.

- **Snapshot operations description:**

Export / Private	Export / Private the snapshot VD.
Rollback	Rollback the snapshot VD to the original.
Delete	Delete the snapshot VD.
Attach	Attach to a LUN.
Detach	Detach to a LUN.
List LUN	List attached LUN(s).

3.5.6 Logical unit

“Logical unit” can view the status of attached logical unit number of each VD.

User can attach LUN by clicking the “  ”. “Host” must enter a fibre channel node name for access control, or fill-in wildcard “*”, which means

every host can access the volume. Choose LUN number and permission, then click “ ”.

VD :

Host (FC node name) :

Target (FC node name) :

LUN :

Permission : Read-only Read-write

Figure 3.5.6.1

Host	Target	LUN	Permission	VD name
* <input type="button" value="Confirm"/>	2000001378AC0019	0	Read write	VD-01
200000051E4214B8 <input type="button" value="Detach"/>	2000001378AC0019	1	Read write	VD-02

Figure 3.5.6.2

(Figure 3.5.6.2: ULTRASTOR RS16 FS, VD-01 is attached to LUN 0 and every host can access. VD-02 is attached to LUN 1 and only FC node name which is named “200000051E4214B8” can access.)

- **LUN operations description:**

Attach	Attach a logical unit number to a Virtual disk.
Detach	Detach a logical unit number from a Virtual disk.

The matching rules of access control are inspected from top to bottom in sequence. For example: there are 2 rules for the same VD, one is “*”, LUN 0; and the other is “host1”, LUN 1. The other host “host2” can login successfully because it matches the rule 1.

The access will be denied when there is no matching rule.

3.5.7 Example

The following is an example for creating volumes. Example 1 is to create two VDs and set a global spare disk.

- **Example 1**

Example 1 is to create two VDs in one RG, each VD uses global cache volume. Global cache volume is created after system boots up automatically. So, no action is needed to set CV. Then set a global spare disk. Eventually, delete all of them.

Step 1: Create RG (RAID group).

To create the RAID group, please follow the procedures:

Name :

RAID level :

RAID PD slot :

Write Cache :

Standby :

Figure 3.5.7.1

1. Select “/ Volume configuration / RAID group”.
2. Click “ ”.
3. Input a RG Name, choose a RAID level from the list, click “ ” to choose the RAID PD slot(s), then click “ ”.
4. Check the outcome. Click “ ” if all setups are correct.
5. Done. A RG has been created.

No.	Name	Total (GB)	Free (GB)	#PD	#VD	Status	Health	RAID	Enclosure
1	RG-R5	931	931	3	0	Online	Good	RAID 5	Local

Figure 3.5.7.2

(Figure 3.5.7.2: Creating a RAID 5 with 3 physical disks, named “RG-R5”. The total size is 931GB. Because there is no related VD, free size still remains 931GB.)

Step 2: Create VD (Virtual disk).

To create a data user volume, please follow the procedures.

Name :
RG name :
Capacity (GB) :
Stripe height (KB) :
Block size (B) :
Read/Write : Write-through cache Write-back cache
Priority : High priority Middle priority Low priority
Bg rate :

Figure 3.5.7.3

1. Select “/ **Volume configuration / Virtual disk**”.
2. Click “ ”.
3. Input a VD name, choose a RG Name and enter a size of VD; decide the stripe high, block size, read/write mode and set priority, finally click “ ”.
4. Done. A VD has been created.
5. Do one more time to create another VD.

No.	Name	Size (GB)	Right	Priority	Bg rate	Status	Health	R %	RAID	#LUN	Snapshot (MB)	#Snapshot	RG name
1	VD-R5-1	50	WB	HI	4	Initiating	Optimal	86	RAID 5	1	0/0	0	RG-R5
2	VD-R5-2	64	WB	HI	4	Initiating	Optimal	0	RAID 5	1	0/0	0	RG-R5

Figure 3.5.7.4

(Figure 3.5.7.4: Create VDs named “VD-R5-1” and “VD-R5-2”. Regarding to “RG-R5”, the size of “VD-R5-1” is 50GB, the size of “VD-R5-2” is 64GB. “VD-R5-1” is initialing about 86%. There is no LUN attached.)

Step 3: Attach LUN to VD.

There are 2 methods to attach LUN to VD.

1. In “/ **Volume configuration / Virtual disk**”, mouse moves to the gray button next to the VD number; click “Attach LUN”.
2. In “/ **Volume configuration / Logical unit**”, click “ ”.

The procedures are as follows:

VD :

Host (FC node name) :

Target (FC node name) :

LUN :

Permission : Read-only Read-write

Figure 3.5.7.5

1. Select a VD.
2. Input “**Host**” name, which is a FC node name for access control, or fill-in wildcard “*”, which means every host can access to this volume. Choose LUN and permission, then click “”.
3. Done.

Host	Target	LUN	Permission	VD name
*	2000001378AC0019	0	Read write	VD-R5-1
200000051E4214B8	2000001378AC0019	1	Read write	VD-R5-2

Figure 3.5.7.6

(Figure 3.5.7.6: VD-R5-1 is attached to LUN 0. VD-R5-2 is attached LUN 1.)



Tips
The matching rules of access control are from top to bottom in sequence.

Step 4: Set global spare disk.

To set global spare disks, please follow the procedures.

1. Select “/ **Volume configuration / Physical disk**”.
2. Mouse moves to the gray button next to the PD slot; click “**Set Global space**”.
3. “**GS**” icon is shown in “**Usage**” column.

Slot	Size (GB)	RG name	Status	Health	Usage	Vendor	Serial	Type	Write cache	Standby
1	465	RG-R5	Online	Good	RD	Maxtor	H80DMBPH	SATA2	Enabled	Disabled
2	465	RG-R5	Online	Good	RD	Maxtor	H81173QH	SATA2	Enabled	Disabled
3	465	RG-R5	Online	Good	RD	Seagate	3PM0H4C0	SATA2	Enabled	Disabled
4	465		Online	Good	GS	Seagate	3PM0FRH7	SATA2	Enabled	Disabled
5	33		Online	Good	FR	HITACHI	J3XADKPJ	SAS	Enabled	Disabled
6	33		Online	Good	FR	HITACHI	J3XAB71J	SAS	Enabled	Disabled
7	33		Online	Good	FR	HITACHI	J3XAE5MJ	SAS	Enabled	Disabled
8	33		Online	Good	FR	HITACHI	J3XAAYRJ	SAS	Enabled	Disabled

Figure 3.5.7.7

(Figure 3.5.8.7: Slot 4 is set as global spare disk.)

Step 5: Done. They can be used as disks.

Delete VDs, RG, please follow the steps listed below.

Step 6: Detach LUN from VD.

In “/ Volume configuration / Logical unit”,

Host	Target	LUN	Permission	VD name
*	2000001378AC0019	0	Read write	VD-R5-1
2000001378AC0019	2000001378AC0019	1	Read write	VD-R5-2

Figure 3.5.7.8

1. Mouse moves to the gray button next to the LUN; click “**Detach**”. There will pop up a confirmation page.
2. Choose “OK”.
3. Done.

Step 7: Delete VD (Virtual disk).

To delete the Virtual disk, please follow the procedures:

1. Select “/ Volume configuration / Virtual disk”.
2. Mouse moves to the gray button next to the VD number; click “**Delete**”. There will pop up a confirmation page, click “**OK**”.
3. Done. Then, the VDs are deleted.



Tips

When deleting VD, the attached LUN(s) related to this VD will be detached automatically.

Step 8: Delete RG (RAID group).

To delete the RAID group, please follow the procedures:

1. Select **“/ Volume configuration / RAID group”**.
2. Select a RG which is no VD related on this RG, otherwise the VD(s) on this RG must be deleted first.
3. Mouse moves to the gray button next to the RG number click **“Delete”**.
4. There will pop up a confirmation page, click **“OK”**.
5. Done. The RG has been deleted.



Tips

The action of deleting one RG will succeed only when all of the related VD(s) are deleted in this RG. Otherwise, it will have an error when deleting this RG.

Step 9: Free global spare disk.

To free global spare disks, please follow the procedures.

1. Select **“/ Volume configuration / Physical disk”**.
2. Mouse moves to the gray button next to the PD slot; click **“Set Free disk”**.

Step 10: Done, all volumes have been deleted.

3.6 Enclosure management

“**Enclosure management**” allows managing enclosure information including “**SES configuration**”, “**Hardware monitor**”, “**S.M.A.R.T.**” and “**UPS**”. For the enclosure management, there are many sensors for different purposes, such as temperature sensors, voltage sensors, hard disks, fan sensors, power sensors, and LED status. Due to the different hardware characteristics among these sensors, they have different polling intervals. Below are the details of polling time intervals:

1. Temperature sensors: 1 minute.
2. Voltage sensors: 1 minute.
3. Hard disk sensors: 10 minutes.
4. Fan sensors: 10 seconds . When there are 3 errors consecutively, controller sends ERROR event log.
5. Power sensors: 10 seconds, when there are 3 errors consecutively, controller sends ERROR event log.
6. LED status: 10 seconds.

SES configuration	Access control for SES management
Hardware monitor	System monitored voltage, temperature and battery backup module
S.M.A.R.T.	Self-monitoring analysis and reporting technology for physical disks
UPS	Uninterruptible power supply

Figure 3.6.1

3.6.1 SES configuration

SES represents **SCSI Enclosure Services**, one of the enclosure management standards. “**SES configuration**” can enable or disable the management of SES.

Host	Target	LUN
*	2000001378AC0019	0

Figure 3.6.1.1

(Figure 3.6.1.1: Enable SES in LUN 0, and can be accessed from every host)

The SES client software is available at the following web site:

SANtools: <http://www.santools.com/>

3.6.2 Hardware monitor

“**Hardware monitor**” can view the information of current voltage and temperature.

Item	Information
+1.2V:	+1.23 V (min = +1.14 V, max = +1.28 V)
+3.3V:	+3.38 V (min = +3.10 V, max = +3.55 V)
+5V:	+5.02 V (min = +4.80 V, max = +5.35 V)
+12V:	+12.16 V (min = +10.80 V, max = +13.20 V)
+1.8V:	+1.86 V (min = +1.71 V, max = +1.93 V)
PSU +5V(BPL7N):	+5.02 V (min = +4.70 V, max = +5.35 V)
PSU +12V(BPL7N):	+12.04 V (min = +10.80 V, max = +13.20 V)
PSU +3.3V(BPL7N):	+3.31 V (min = +3.10 V, max = +3.55 V)
Core Processor:	+37.5 (C) (hyst = +0.0 (C), high = +80.0 (C))
Onboard SAS Device 1:	+40.0 (C) (hyst = +0.0 (C), high = +80.0 (C))
Onboard SAS Device 2:	+39.0 (C) (hyst = +0.0 (C), high = +80.0 (C))
Location 1(BPL7N):	+32.0 (C) (hyst = +0.0 (C), high = +49.0 (C))
Location 2(BPL7N):	+32.0 (C) (hyst = +0.0 (C), high = +49.0 (C))
Location 3(BPL7N):	+32.0 (C) (hyst = +0.0 (C), high = +49.0 (C))
Location 4(BPL7N):	+32.5 (C) (hyst = +0.0 (C), high = +49.0 (C))
Location 5(BPL7N):	+33.5 (C) (hyst = +0.0 (C), high = +49.0 (C))
Location 6(BPL7N):	+33.0 (C) (hyst = +0.0 (C), high = +49.0 (C))
Location 7(BPL7N):	+34.5 (C) (hyst = +0.0 (C), high = +49.0 (C))
Location 8(BPL7N):	+32.5 (C) (hyst = +0.0 (C), high = +49.0 (C))
Power Supply:	good
FAN1(BPL7N):	good (2678 RPM)
FAN2(BPL7N):	good (2657 RPM)
FAN3(BPL7N):	good (2657 RPM)
FAN4(BPL7N):	good (2721 RPM)

Auto shutdown :

Confirm

Figure 3.6.2.1

If “**Auto shutdown**” has been checked, the system will shutdown automatically when voltage or temperature is out of the normal range. For better data protection, please check “**Auto Shutdown**”.

For better protection and avoiding single short period of high temperature triggering auto shutdown, controllers use multiple condition judgments for auto shutdown, below are the details of when the Auto shutdown will be triggered.

1. There are 3 sensors placed on controllers for temperature checking, they are on core processor, PCI-X bridge, and daughter board. controller will check each sensor for every 30 seconds. When one of these sensor is over high temperature value for continuous 3 minutes, auto shutdown will be triggered immediately.
2. The core processor temperature limit is 85°. The PCI-X bridge temperature limit is 80°. The daughter board temperature limit is 80°.
3. If the high temperature situation doesn't last for 3 minutes, controller will not do auto shutdown.

3.6.3 Hard drive S.M.A.R.T. support

S.M.A.R.T. (Self-Monitoring Analysis and Reporting Technology) is a diagnostic tool for hard drives to deliver warning of drive failures in advance. S.M.A.R.T. provides users chances to take actions before possible drive failure.

S.M.A.R.T. measures many attributes of the hard drive all the time and inspects the properties of hard drives which are close to be out of tolerance. The advanced notice of possible hard drive failure can allow users to back up hard drive or replace the hard drive. This is much better than hard drive crash when it is writing data or rebuilding a failed hard drive.

“**S.M.A.R.T.**” can display S.M.A.R.T. information of hard drives. The number is the current value; the number in parenthesis is the threshold value. The threshold values of hard drive vendors are different; please refer to vendors’ specification for details.

S.M.A.R.T. only supports SATA drive. SAS drive does not have. It will show N/A in this web page.

Local

Slot	HDD type	Read error rate	Spin up time	Reallocated sector count	Seek error rate	Spin up retries	Calibration retries	Temperature (C)
1	SATA	59(6)	98(0)	100(36)	87(30)	100(97)	N/A	32
2	SATA	N/A	220(63)	180(63)	253(0)	253(157)	253(223)	37
3	SATA	N/A	227(63)	253(63)	253(0)	253(157)	253(223)	32
4	SATA	100(51)	100(25)	98(11)	100(51)	100(51)	100(0)	29
5	SATA	100(60)	147(24)	100(5)	100(67)	100(60)	N/A	33
6	SATA	100(60)	149(24)	100(5)	100(67)	100(60)	N/A	31
7	SATA	N/A	220(63)	253(63)	253(0)	253(157)	253(223)	36
8	SATA	100(51)	100(25)	100(11)	100(51)	100(51)	100(0)	23
9	SATA	100(60)	140(24)	100(5)	100(67)	100(60)	N/A	33
10	SATA	100(51)	100(25)	100(11)	100(51)	100(51)	84(0)	30
11	SATA	100(51)	100(25)	100(11)	100(51)	100(51)	100(0)	30
12	SATA	57(6)	98(0)	100(36)	80(30)	100(97)	N/A	34
13	SATA	100(51)	100(25)	100(11)	100(51)	100(51)	100(0)	29
14	SATA	61(6)	98(0)	100(36)	82(30)	100(97)	N/A	33
15	SATA	69(6)	98(0)	100(36)	81(30)	100(97)	N/A	34
16	SATA	65(6)	98(0)	100(36)	81(30)	100(97)	N/A	30

Figure 3.6.3.1

3.6.4 UPS

“**UPS**” can set up UPS (Uninterruptible Power Supply).

UPS type :

Shutdown battery level (%) :

Shutdown delay (s) :

Shutdown UPS :

Status :

Battery level : 

Figure 3.6.4.1

Currently, the system only supports and communicates with smart-UPS of APC (American Power Conversion Corp.) UPS. Please review the details from the website: <http://www.apc.com/>.

First, connect the system and APC UPS via RS-232 for communication. Then set up the shutdown values when power is failed. UPS in other companies can work well, but they have no such communication feature.

UPS Type	Select UPS Type. Choose Smart-UPS for APC, None for other vendors or no UPS.
Shutdown Battery Level (%)	When below the setting level, system will shutdown. Setting level to “0” will disable UPS.
Shutdown Delay (s)	If power failure occurred, the system will delay the shutdown specified. Setting delay to “0” will disable the function.
Shutdown UPS	Select ON, when power is down, UPS will shut down by itself after the system shutdown successfully. After power comes back, UPS will start working and notify system to boot up. OFF will not.
Status	The status of UPS. “Detecting...” “Running” “Unable to detect UPS” “Communication lost” “UPS reboot in progress” “UPS shutdown in progress” “Batteries failed. Please change them NOW!”

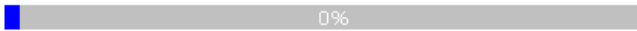
Battery Level (%)	Current percentage of battery level.
--------------------------	--------------------------------------

3.7 System maintenance

“**Maintenance**” allows the operation of system functions which include “**System information**” to show the system version, “**Upgrade**” to the latest firmware, “**Reset to factory default**” to reset all controller configuration values to factory settings, “**Import and export**” to import and export all controller configuration, “**Event log**” to view system event log to record critical events, and “**Reboot and shutdown**” to either reboot or shutdown the system.

System information	System information
Upgrade	Remote upload firmware
Reset to factory default	Reset to factory default
Import and export	Import/export configurations
Event log	System event log to record critical events
Reboot and shutdown	Reboot or shutdown system

Figure 3.7.1

3.7.1 System information

“**System information**” can display system information (including firmware version), CPU type, installed system memory, and controller serial number.

3.7.2 Upgrade

“**Upgrade**” can upgrade firmware. Please prepare new firmware file named “**xxxx.bin**” in local hard drive, then click “**Browse...**” to select the file. Click “**Confirm**”, it will pop up a message “Upgrade system now? If you want to downgrade to the previous FW later (not recommend), please export your system configuration in advance”, click “**Cancel**” to export system configuration in advance, then click “**OK**” to start to upgrade firmware.

Browse the firmware to upgrade :
[Export configuration](#)

Figure 3.7.2.1

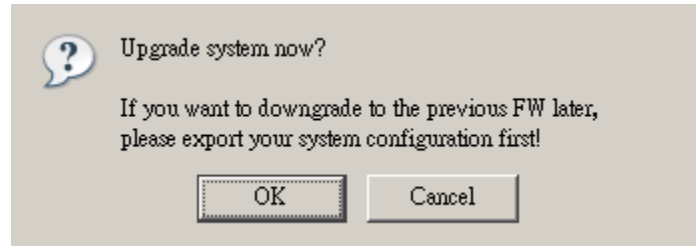

Figure 3.7.2.2

When upgrading, there is a progress bar running. After finished upgrading, the system must reboot manually to make the new firmware took effect.



Tips
Please contact with tech@enhance-tech.com for latest firmware.

3.7.3 Reset to factory default

“Reset to factory default” allows user to reset controller to factory default setting.

Sure to reset to factory default?

Figure 3.7.3.1

Reset to default value, the password is: **1234**, and IP address to default DHCP.

Default IP address: **192.168.10.50** (DHCP)

Default subnet mask: **255.255.255.0**

Default gateway: **192.168.10.254**

3.7.4 Import and export

“Import and export” allows user to save system configuration values: export, and apply all configuration: import. For the volume configuration setting, the

values are available in export and not available in import which can avoid confliction/date-deleting between two controllers. That says if one controller already exists valuable data in the disks and user may forget to overwrite it. Use import could return to original configuration. If the volume setting was also imported, user's current data will be overwritten.



Figure 3.7.4.1

1. **Import:** Import all system configurations excluding volume configuration.
2. **Export:** Export all configurations to a file.



Caution
“Import” will import all system configurations excluding volume configuration; the current configurations will be replaced.

3.7.5 Event log

“**Event log**” can view the event messages. Check the checkbox of INFO, WARNING, ERROR to choose the level of display event log. Clicking “” button will save the whole event log as a text file with file name “log-ModelName-SerialNumber-Date-Time.txt” (e.g., log-ULTRASTOR RS16 FS-a00001-20080501-120000.txt). Click “” button will clear event log. Click “” button will stop alarm if system alerts.

Show events : INFO WARNING ERROR

Type	Time	Content
INFO	2008/05/28 16:14:46	VD VD-R5-2 starts initialization.
INFO	2008/05/28 16:14:46	VD VD-R5-1 completes the initialization.
INFO	2008/05/28 16:11:45	PD 4 has been configured as a global spare disk.
INFO	2008/05/28 16:07:20	VD VD-R5-2 has been created.
INFO	2008/05/28 16:07:01	VD VD-R5-1 starts initialization.
INFO	2008/05/28 16:07:01	VD VD-R5-1 has been created.
INFO	2008/05/28 16:04:25	RG RG-R5 has been created.
INFO	2008/05/28 16:02:57	RG RG-R5 has been deleted.
INFO	2008/05/28 16:02:53	RG RG-R0 has been deleted.
INFO	2008/05/28 16:02:45	VD VD-02 has been deleted.
INFO	2008/05/28 16:02:41	VD SnapVD-02 has been deleted.
INFO	2008/05/28 16:02:41	VD SnapVD-01 has been deleted.
INFO	2008/05/28 16:02:41	VD VD-01 has been deleted.

Figure 3.7.5.1

The event log is displayed in reverse order which means the latest event log is on the first page. The event logs are actually saved in the first four hard drives; each hard drive has one copy of event log. For one controller, there are four copies of event logs to make sure users can check event log any time when there is/are failed disk(s).



Tips
Please plug-in any of the first four hard drives, then event logs can be saved and displayed in next system boot up. Otherwise, the event logs would be disappeared.

3.7.6 Reboot and shutdown

“**Reboot and shutdown**” displays “**Reboot**” and “**Shutdown**” buttons. Before power off, it’s better to execute “**Shutdown**” to flush the data from cache to physical disks. The step is necessary for data protection.



Figure 3.7.6.1

3.8 Logout

For security reason, “**Logout**” allows users logout when no user is operating the system. Re-login the system; please enter username and password again.

Chapter 4 Advanced operation

4.1 Rebuild

If one physical disk of the RG which is set as protected RAID level (e.g.: RAID 3, RAID 5, or RAID 6) is FAILED or has been unplugged/removed, then the status of RG is changed to degraded mode, the system will search/detect spare disk to rebuild the degraded RG to a complete one. It will detect dedicated spare disk as rebuild disk first, then global spare disk.

RS16FS controllers support Auto-Rebuild. The following is the scenario:

Take RAID 6 for example:

1. When there is no global spare disk or dedicated spare disk in the system, controller will be in degraded mode and wait until (A) there is one disk assigned as spare disk, or (B) the failed disk is removed and replaced with new clean disk, then the Auto-Rebuild starts. The new disk will be a spare disk to the original RG automatically.

If the new added disk is not clean (with other RG information), it would be marked as RS (reserved) and the system will not start "auto-rebuild".

If this disk is not belonging to any existing RG, it would be FR (Free) disk and the system will start Auto-Rebuild.

If user only removes the failed disk and plugs the same failed disk in the same slot again, the auto-rebuild will start running. But rebuilding in the same failed disk may impact customer data if the status of disk is unstable. **Proavio, U.S.A.** suggests all customers not to rebuild in the failed disk for better data protection.

2. When there is enough global spare disk(s) or dedicated spare disk(s) for the degraded array, controller starts Auto-Rebuild immediately. And in RAID 6, if there is another disk failure occurs during rebuilding, controller will start the above Auto-Rebuild process as well. Auto-Rebuild feature only works at that the status of RG is "**Online**". It will not work at "**Offline**". Thus, it will not conflict with the "**Roaming**".
3. In degraded mode, the status of RG is "**Degraded**". When rebuilding, the status of RG/VD will be "**Rebuild**", the column "**R%**" in VD will display the ratio in percentage. After complete rebuilding, the status will become "Online". RG will become completely one.

**Tips**

“**Set dedicated spare**” is not available if there is no RG or only RG of RAID 0, JBOD, because user can not set dedicated spare disk to RAID 0 & JBOD.

Sometimes, rebuild is called recover; they are the same meaning. The following table is the relationship between RAID levels and rebuild.

RAID 0	Disk striping. No protection for data. RG fails if any hard drive fails or unplugs.
RAID 1	Disk mirroring over 2 disks. RAID 1 allows one hard drive fails or unplugging. Need one new hard drive to insert to the system and rebuild to be completed.
N-way mirror	Extension to RAID 1 level. It has N copies of the disk. N-way mirror allows N-1 hard drives failure or unplugging.
RAID 3	Striping with parity on the dedicated disk. RAID 3 allows one hard drive failure or unplugging.
RAID 5	Striping with interspersed parity over the member disks. RAID 5 allows one hard drive failure or unplugging.
RAID 6	2-dimensional parity protection over the member disks. RAID 6 allows two hard drives failure or unplugging. If it needs to rebuild two hard drives at the same time, it will rebuild the first one, then the other in sequence.
RAID 0+1	Mirroring of RAID 0 volumes. RAID 0+1 allows two hard drive failures or unplugging, but at the same array.
RAID 10	Striping over the member of RAID 1 volumes. RAID 10 allows two hard drive failure or unplugging, but in different arrays.
RAID 30	Striping over the member of RAID 3 volumes. RAID 30 allows two hard drive failure or unplugging, but in different arrays.
RAID 50	Striping over the member of RAID 5 volumes. RAID 50 allows two hard drive failures or unplugging, but in different arrays.
RAID 60	Striping over the member of RAID 6 volumes. RAID 40 allows four hard drive failures or unplugging, every two in different

	arrays.
JBOD	The abbreviation of “ J ust a B unch O f D isks”. No data protection. RG fails if any hard drive failures or unplugs.

4.2 RG migration

To migrate the RAID level, please follow below procedures.

1. Select “/ **Volume configuration / RAID group**”.
2. Mouse moves to the gray button next to the RG number; click “**Migrate**”.
3. Change the RAID level by clicking the down arrow to “**RAID 5**”. There will be a pup-up which indicates that HDD is not enough to support the new setting of RAID level, click “” to increase hard drives, then click “” to go back to setup page. When doing migration to lower RAID level, such as the original RAID level is RAID 6 and user wants to migrate to RAID 0, system will evaluate whether this operation is safe or not, and appear a message of “**Sure to migrate to a lower protection array?**” to give user warning.

Name :

RAID level :

RAID PD slot :

Figure 4.2.1

4. Double check the setting of RAID level and RAID PD slot. If there is no problem, click “”.
5. Finally a confirmation page shows the detail of RAID information. If there is no problem, click “” to start migration. System also pops up a message of “**Warning: power lost during migration may cause damage of data!**” to give user warning. When the power is abnormally off during the migration, the data is in high risk.
6. Migration starts and it can be seen from the “**status**” of a RG with “**Migrating**”. In “/ **Volume configuration / Virtual disk**”, it displays a “**Migrating**” in “**Status**” and complete percentage of migration in “**R%**”.

No.	Name	Total (GB)	Free (GB)	#PD	#VD	Status	Health	RAID	Enclosure
1	RG-R0->R5	1396	1386	4	1	Migrating	Good	RAID 5	Local

Figure 4.2.2

(Figure 4.2.2: A RAID 0 with 4 physical disks migrates to RAID 5 with 5 physical disks.)

No.	Name	Size (GB)	Right	Priority	Bg rate	Status	Health	R %	RAID	#LUN	Snapshot (MB)	#Snapshot	RG name
1	VD-R0->R5	10	WB	HI	4	Migrating	Optimal	6	RAID 5	0	0/0	0	RG-R0->R5

Figure 4.2.3

(Figure 4.2.3: A RAID 0 migrates to RAID 5, the complete percentage is 14%.)

To do migration, the total size of RG must be larger or equal to the original RG. It does not allow expanding the same RAID level with the same hard disks of original RG.

The operation is not allowed when RG is being migrated. System would reject following operations:

1. Add dedicated spare.
2. Remove a dedicated spare.
3. Create a new VD.
4. Delete a VD.
5. Extend a VD.
6. Scrub a VD.
7. Perform yet another migration operation.
8. Scrub entire RG.
9. Take a new snapshot.
10. Delete an existing snapshot.
11. Export a snapshot.
12. Rollback to a snapshot.



Caution

RG Migration cannot be executed during rebuild or VD extension.

4.3 VD Extension

To extend VD size, please follow the procedures.

1. Select “/ **Volume configuration / Virtual disk**”.
2. Mouse moves to the gray button next to the VD number; click “**Extend**”.
3. Change the size. The size must be larger than the original, and then click “” to start extension.

Size :

Free : 1386 (GB)

Figure 4.3.1

4. Extension starts. If VD needs initialization, it will display an “**Initiating**” in “**Status**” and complete percentage of initialization in “**R%**”.

No.	Name	Size (GB)	Right	Priority	Bg rate	Status	Health	R %	RAID	#LUN	Snapshot (MB)	#Snapshot	RG name
1	VD-R0->R5	20	WB	HI	4	Initiating	Optimal	69	RAID 5	0	0/0	0	RG-R0->R5

Figure 4.3.2

(Figure 4.3.2: Extend VD-R5 from 20GB to 40GB.)



Tips
The size of VD extension must be larger than original.



Caution
VD extension cannot be executed during rebuild or migration.

4.4 Snapshot / Rollback

Snapshot-on-the-box captures the instant state of data in the target volume in a logical sense. The underlying logic is Copy-on-Write -- moving out the data which would be written to certain location where a write action occurs since the time of data capture. The certain location, named as “Snap VD”, is essentially a new VD. which can be attached to a LUN provisioned to a host as a disk like other

ordinary VDs in the system. Rollback restores the data back to the state of any time which was previously captured in case for any unfortunate reason it might be (e.g. virus attack, data corruption, human errors and so on). Snap VD is allocated within the same RG in which the snapshot is taken, we suggest to reserve 20% of RG size or more for snapshot space. Please refer to Figure 4.4.1 for snapshot concept.

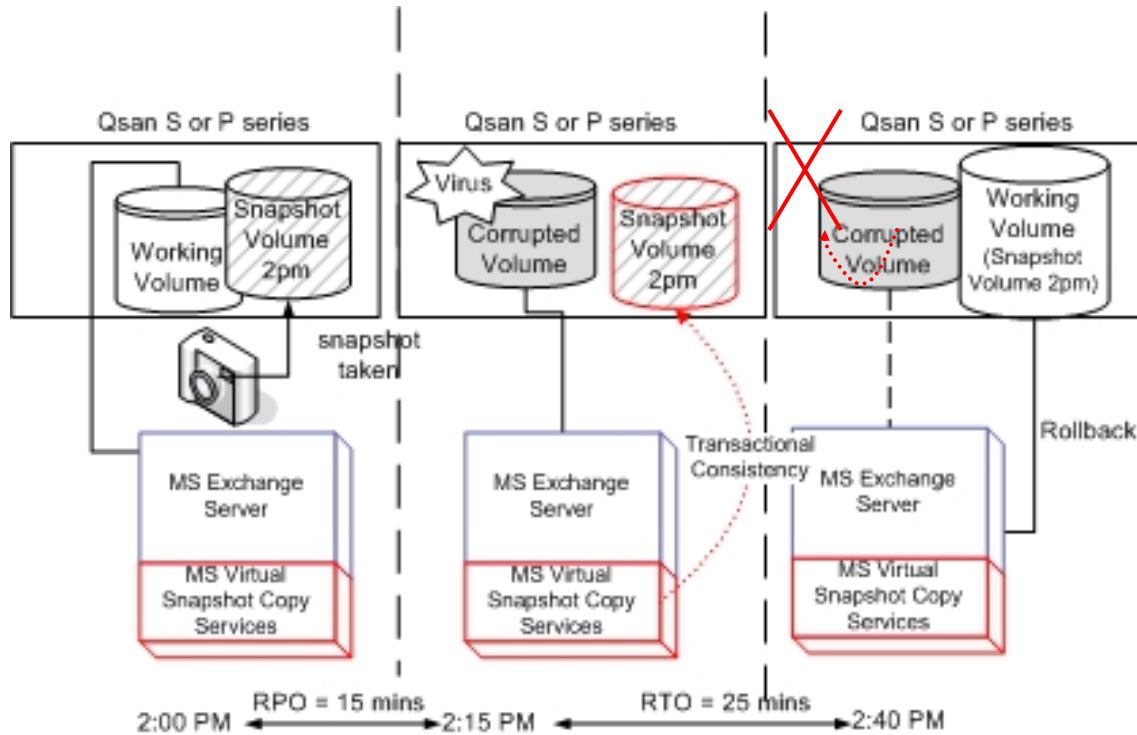

Figure 4.4.1



Caution
 Snapshot / rollback features need **512MB** RAM at least. Please also refer to RAM certification list in Appendix A.

4.4.1 Create snapshot volume

To take a snapshot of the data, please follow the procedures.

1. Select “/ **Volume configuration / Virtual disk**”.
2. Mouse moves to the gray button next to the VD number; click “**Set snapshot space**”.
3. Set up the size for snapshot. The minimum size is suggested to be **20%** of VD size, then click “ ”. It will go back to the

VD page and the size will show in snapshot column. It may not be the same as the number entered because some size is reserved for snapshot internal usage. There will be 2 numbers in “**Snapshot (MB)**” column. These numbers mean “**Used snapshot space**” and “**Total snapshot space**”.

4. There are two methods to take snapshot. In “/ **Volume configuration / Virtual disk**”, mouse moves to the gray button next to the VD number; click “**Take snapshot**”. Or in “/ **Volume configuration / Snapshot**”, click “ **Take snapshot** ”.
5. Enter a snapshot name, then click “ **Confirm** ”. A snapshot VD is created.
6. Select “/ **Volume configuration / Snapshot**” to display all snapshot VDs related to the VD.

Linked snapshot for VD: -VD-01-

No.	Name	Used (MB)	Exported	Right	#LUN	Created time
1	SnapVD-01	0	No	N/A	N/A	Wed May 28 15:22:50 2008

Export
Rollback
Delete

<< Back
Cleanup
Auto snapshot
Take snapshot

Figure 4.4.1.1

(Figure 4.4.1.1: This is Snap VD, but it is not exported.)

7. Mouse moves to the gray button next to the Snapshot VD number; click “**Export**”. Enter a capacity for snapshot VD. If size is zero, the exported snapshot VD will be read only. Otherwise, the exported snapshot VD can be read/written, and the size will be the maximum capacity to read/write.
8. Attach a LUN for snapshot VD. Please refer to the previous chapter for attaching a LUN.
9. Done. It can be used as a disk.

Linked snapshot for VD: -VD-01-

No.	Name	Used (MB)	Exported	Right	#LUN	Created time
1	SnapVD-01	0	Yes	RO	0	Wed May 28 15:22:50 2008
2	SnapVD-02	0	Yes	RW	0	Wed May 28 15:26:40 2008

Unexport
Rollback
Delete
Attach
Detach
List LUN

<< Back
Cleanup
Auto snapshot
Take snapshot

Figure 4.4.1.2

(Figure 4.4.1.2: This is the list of “VD-01”. There are two snapshots in “VD-01”. Snapshot VD “SnapVD-01” is exported to read only, “SnapVD-02” is exported to read/write.)

10. There are two methods to clean all snapshots. In “/ **Volume configuration / Virtual disk**”, mouse moves to the gray button next to the VD number; click “**Cleanup snapshot**”. Or in “/ **Volume configuration / Snapshot**”, click “”.
11. Cleanup will delete all snapshots related to the VD and release snapshot space.

Snapshot has some constraints as followings:

1. Minimum RAM size of enabling snapshot is **512MB**.
2. For performance and future rollback, system saves snapshot with names in sequences. For example, three snapshots has been taken and named “SnapVD-01”(first), “SnapVD-02” and “SnapVD-03”(last). When deleting “SnapVD-02”, both of “SnapVD-02” and “SnapVD-03” will be deleted because “SnapVD-03” is related to “SnapVD-02”.
3. For resource management, maximum number of snapshots in system is **32**.
4. If the snapshot space is full, system will send a warning message of space full and the new taken snapshot will replace the oldest snapshot in rotational sequence by executing auto snapshot, but new snapshot can not be taken by manual because system does not know which snapshot VDs can be deleted.

4.4.2 Auto snapshot

The snapshot copies can be taken manually or by schedule such as hourly or daily. Please follow the procedures.

1. There are two methods to set auto snapshot. In “/ **Volume configuration / Virtual disk**”, mouse moves to the gray button next to the VD number; click “**Auto snapshot**”. Or in “/ **Volume configuration / Snapshot**”, click “”.
2. The auto snapshot can be set monthly, weekly, daily, or hourly.
3. Done. It will take snapshots automatically.

All
Months to take snapshots : 01 02 03 04
 05 06 07 08
 09 10 11 12

All
Weeks to take snapshots : 1 2 3 4
 5

All
Days to take snapshots : Sun Mon Tue Wed
 Thu Fri Sat

All
Hours to take snapshots : 00 01 02 03
 04 05 06 07
 08 09 10 11
 12 13 14 15
 16 17 18 19
 20 21 22 23

Figure 4.4.2.1

(Figure 4.4.2.1: It will take snapshots every month, and keep the last 32 snapshot copies.)



Tips
Daily snapshot will be taken at every 00:00. Weekly snapshot will be taken every Sunday 00:00. Monthly snapshot will be taken every first day of month 00:00.

4.4.3 Rollback

The data in snapshot VD can rollback to original VD. Please follow the procedures.

1. Select “/ **Volume configuration / Snapshot**”.
2. Mouse moves to the gray button next to the Snap VD number which user wants to rollback the data; click “**Rollback**”.
3. Done, the data in snapshot VD will rollback to original VD.

Rollback has some constraints as described in the followings:

1. Minimum RAM size of enabling rollback is **512MB**.

2. When making rollback, the original VD cannot be accessed for a while. At the same time, the system connects to original VD and snaps VD, and then starts rollback.
3. During rollback, data from snap VD to original VD, the original VD can be accessed and the data in VD just like it has finished rollback. At the same time, the other related snap VD(s) cannot be accessed.
4. After rollback, the other snapshot VD(s) after the VD which is doing rollback will be deleted.



Caution

Before executing rollback, it is better to dismount file system for flushing data from cache to disks in OS first. System sends pop-up message when user executes rollback function.

4.5 Disk roaming

Physical disks can be re-sequenced in the same system or move all physical disks from system-1 to system-2. This is called disk roaming. System can execute disk roaming online. Please follow the procedures.

1. Select “/ **Volume configuration / RAID group**”.
2. Mouse moves to the gray button next to the RG number; click “**Deactivate**”.
3. Move all PDs related to the RG to another system.
4. Mouse moves to the gray button next to the RG number; click “**Activate**”.
5. Done.

Disk roaming has some constraints as described in the followings:

1. Check the firmware of two systems first. It is better that both systems have the same firmware version or newer.
2. All physical disks of related RG should be moved from system-1 to system-2 together. The configuration of both RG and VD will be kept but LUN configuration will be cleared in order to avoid conflict with system-2.

4.6 SAS JBOD expansion

RS16FS has SAS JBOD expansion port to connect extra SAS JBOD controllers. When connecting to a SAS JBOD which can be detected, it displays tabs on the

top in “/ **Volume configuration / Physical disk**”. For example, Local, JBOD 1 (vendor model), JBOD 2 (vendor model), ...etc. Local means disks in local controller, and so on. The disks in JBOD can be used as local disks.

Slot	Size (GB)	RG name	Status	Health	Usage	Vendor	Serial	Type	Write cache	Standby
1	33		Online	Good	FR	HITACHI	J3XAB2SJ	SAS	Enabled	Disabled
2	33		Online	Good	FR	HITACHI	J3XAE0DJ	SAS	Enabled	Disabled
3	33		Online	Good	FR	HITACHI	J3XABBLJ	SAS	Enabled	Disabled
4	33		Online	Good	FR	HITACHI	J3XAB27J	SAS	Enabled	Disabled
5	33		Online	Good	FR	HITACHI	J3XAE9KJ	SAS	Enabled	Disabled
6	33		Online	Good	FR	HITACHI	J3XAB4NJ	SAS	Enabled	Disabled
7	33		Online	Good	FR	HITACHI	J3XAASKJ	SAS	Enabled	Disabled
8	33		Online	Good	FR	HITACHI	J3XADGKJ	SAS	Enabled	Disabled
9	68		Online	Good	FR	SEAGATE	3LQ0TJXX	SAS	Enabled	Disabled
10	68		Online	Good	FR	SEAGATE	3LQ0TLNR	SAS	Enabled	Disabled
11	68		Online	Good	FR	SEAGATE	3LQ0WDC7	SAS	Enabled	Disabled
12	68		Online	Good	FR	SEAGATE	3LQ1GX3E	SAS	Enabled	Disabled
13	68		Online	Good	FR	SEAGATE	3LQ0TL2D	SAS	Enabled	Disabled
14	68		Online	Good	FR	SEAGATE	3LQ0TLXN	SAS	Enabled	Disabled
15	68		Online	Good	FR	SEAGATE	3LQ0TKZH	SAS	Enabled	Disabled
16	68		Online	Good	FR	SEAGATE	3LQ0TMSF	SAS	Enabled	Disabled

Figure 4.6.1

(Figure 4.6.1: Display all PDs in JBOD 1.)

“/ **Enclosure management / S.M.A.R.T.**” can displays S.M.A.R.T. information of all PDs, including Local and all SAS JBODs.

Local

Slot	HDD type	Read error rate	Spin up time	Reallocated sector count	Seek error rate	Spin up retries	Calibration retries	Temperature (C)
1	SATA	200(51)	121(21)	200(140)	200(51)	100(51)	100(51)	31
2	SATA	200(51)	120(21)	199(140)	200(51)	100(51)	100(51)	33
3	SATA	200(51)	119(21)	196(140)	200(51)	100(51)	100(51)	35
4	SATA	200(51)	121(21)	197(140)	200(51)	100(51)	100(51)	32
5	SATA	100(51)	100(25)	100(11)	100(51)	100(51)	96(0)	31
6	SATA	100(51)	100(25)	100(11)	100(51)	100(51)	100(0)	30
7	SATA	100(51)	100(25)	100(11)	100(51)	100(51)	100(0)	30
8	SATA2	100(16)	109(24)	100(5)	100(67)	100(60)	N/A	33
9	SATA	100(51)	100(25)	100(11)	100(51)	100(51)	100(0)	33
10	SATA	69(6)	98(0)	100(36)	88(30)	100(97)	N/A	37
11	SATA2	100(16)	108(24)	100(5)	100(67)	100(60)	N/A	34
12	SATA	95(60)	110(24)	100(5)	100(67)	100(60)	N/A	33
13	SATA2	200(51)	235(21)	200(140)	200(51)	100(51)	100(51)	39
14	SATA2	200(51)	238(21)	200(140)	200(51)	100(51)	100(51)	42
15	SATA2	103(6)	89(0)	100(36)	89(30)	100(97)	N/A	38
16	SATA2	102(6)	88(0)	100(36)	88(30)	100(97)	N/A	37

JBOD 1: QSAN J200C (WWN: 50013780029010BD)

Slot	HDD type	Read error rate	Spin up time	Reallocated sector count	Seek error rate	Spin up retries	Calibration retries	Temperature (C)
1	SAS	N/A	N/A	N/A	N/A	N/A	N/A	25
2	SAS	N/A	N/A	N/A	N/A	N/A	N/A	25
3	SAS	N/A	N/A	N/A	N/A	N/A	N/A	24
4	SAS	N/A	N/A	N/A	N/A	N/A	N/A	24
5	SAS	N/A	N/A	N/A	N/A	N/A	N/A	26
6	SAS	N/A	N/A	N/A	N/A	N/A	N/A	25
7	SAS	N/A	N/A	N/A	N/A	N/A	N/A	25
8	SAS	N/A	N/A	N/A	N/A	N/A	N/A	25
9	SAS	N/A	N/A	N/A	N/A	N/A	N/A	25
10	SAS	N/A	N/A	N/A	N/A	N/A	N/A	23
11	SAS	N/A	N/A	N/A	N/A	N/A	N/A	24
12	SAS	N/A	N/A	N/A	N/A	N/A	N/A	23
13	SAS	N/A	N/A	N/A	N/A	N/A	N/A	24
14	SAS	N/A	N/A	N/A	N/A	N/A	N/A	24
15	SAS	N/A	N/A	N/A	N/A	N/A	N/A	23
16	SAS	N/A	N/A	N/A	N/A	N/A	N/A	24

Figure 4.6.2

(Figure 4.6.2: Disk S.M.A.R.T. information of Local and JBOD 1, although S.M.A.R.T. supports SATA disk only.)

SAS JBOD expansion has some constraints as described in the followings:

1. Up to 4 SAS JBODs can be cascaded.
2. Created RG can not use PDs which located in different controllers. It means that RG can be composed of PDs which are all in Local or one SAS JBOD.

3. Global spare disk only supports all RGs which located in the same controller.

4.7 Support Microsoft MPIO

MPIO (Multi-Path Input/Output) use multiple physical paths to create logical "paths" between the server and the storage device. In the case which one or more of these components fails, causing the path to fail, multi-path logic uses an alternate path for I/O. So applications can still access their data.

It needs driver to support Microsoft MPIO, please contact with "sales@Proavio-tech.com" to get the latest MPIO driver.

Please follow the procedures to use MPIO feature.

1. A host with dual Fibre channels connects to controller.
2. Create a RG/VD, attach the VD to two different buses.
3. Install "**ProavioTech Storage Service Setup.exe**" on the host and select "**Multipath IO Driver (MPIO)**".
4. After installation, reboot the host.
5. Rescan disk.
6. Then, there will be one disk running MPIO with round-robin mode.



Caution

Without installing MPIO driver, there will be two disks which show in the computer manager.

Appendix

A. Certification list

- **RAM**

RS16FS RAM Spec: 240-pin, DDR2-533(PC4300), Reg.(register) or UB (Unbuffered), ECC, up to 2GB, 64-bit data bus width (and also 32-bit memory support), x8 or x16 devices, 36-bit addressable, up to 14-bit row address and 10-bit column address.

Vendor	Model
ATP	AJ28K64E8BHE6S, 1GB DDR2-667 (Unbuffered, non-ECC) with SEC
ATP	AJ28K72G8BHE6S, 1GB DDR2-667 (Unbuffered, ECC) with SEC
ATP	AJ64K72F8BHE6S, 512MB DDR2-667 (Unbuffered, ECC) with SEC
ATP	AJ56K72G8BJE6S, 2GB DDR2-667 (Unbuffered, ECC) with Samsung
Unigen	UG64T7200L8DU-6AL, 512MB DDR2-667 (Unbuffered, ECC) with Elpida
Unigen	UG12T7200L8DU-5AM, 1GB DDR2-533 (Unbuffered, ECC) with Elpida
Unigen	UG12T7200L8DR-5AC, 1GB DDR2-533 (Registered, ECC) with Elpida
Unigen	UG25T7200M8DU-5AM, 2GB DDR2-533 (UnBuffered, ECC) with Micron

- **FC HBA card**

Vendor	Model
Brocade	410 (PCI-Express, 2.5 GHz, 4 Gb/s, 1 port, LC style pluggable SFP, multimode optics 850nm) + Finisar FTLF 8524P2BNL
LSI Logic	LSI7204XP-LC (PCI-X, 4 Gb/s, 2 ports, LC style pluggable SFP, multimode optics 850nm) + Picolight PLRXPL-VE-SG4-26
QLogic	QLA2462 (PCI-X 2.0, 266MHz, 4 Gb/s, 2 ports, LC style SFF, multimode optics 850nm) + Finisar FTLF 8524E2KNL
QLogic	QLE2462 (PCI-Express, 2.5 GHz, 4 Gb/s, 2 ports, LC style SFF, multimode optics 850nm) + Finisar FTLF 8524E2KNL

- **Hard drive**

RS16FSsupport SATA I, II disks.

Vendor	Model
Hitachi	Deskstar 7K250, HDS722580VLSA80, 80GB, 7200RPM, SATA, 8M
Hitachi	Deskstar E7K500, HDS725050KLA360, 500GB, 7200RPM, SATA II, 16M
Hitachi	Deskstar 7K80, HDS728040PLA320, 40GB, 7200RPM, SATA II, 2M
Hitachi	Deskstar T7K500, HDT725032VLA360, 320GB, 7200RPM, SATA II, 16M
Hitachi	Deskstar P7K500, HDP725050GLA360, 500GB, 7200RPM, SATA II, 16M
Maxtor	DiamondMax Plus 9, 6Y080M0, 80GB, 7200RPM, SATA, 8M
Maxtor	DiamondMax 11, 6H500F0, 500GB, 7200RPM, SATA 3.0Gb/s, 16M
Samsung	SpinPoint P80, HDSASP0812C, 80GB, 7200RPM, SATA, 8M
Seagate	Barracuda 7200.7, ST380013AS, 80GB, 7200RPM, SATA 1.5Gb/s, 8M
Seagate	Barracuda 7200.7, ST380817AS, 80GB, 7200RPM, SATA 1.5Gb/s, 8M, NCQ
Seagate	Barracuda 7200.8, ST3400832AS, 400GB, 7200RPM, SATA 1.5Gb/s, 8M, NCQ
Seagate	Barracuda 7200.9, ST3500641AS, 500GB, 7200RPM, SATA 3.0Gb/s, 16M, NCQ
Seagate	Barracuda 7200.11, ST31000340AS, 1000GB, 7200RPM, SATA 3.0Gb/s, 32M, NCQ
Seagate	NL35, ST3400633NS, 400GB, 7200RPM, SATA 3.0Gb/s, 16M
Seagate	NL35, ST3500641NS, 500GB, 7200RPM, SATA 3.0Gb/s, 16M
Seagate	Barracuda ES, ST3500630NS, 500GB, 7200RPM, SATA 3.0Gb/s, 16M
Seagate	Barracuda ES, ST3750640NS, 750GB, 7200RPM, SATA 3.0Gb/s, 16M
Seagate	Barracuda ES.2, ST31000340NS, 1000GB, 7200RPM, SATA 3.0Gb/s, 32M
Western Digital	Caviar SE, WD800JD, 80GB, 7200RPM, SATA 3.0Gb/s, 8M
Western Digital	Caviar SE, WD1600JD, 160GB, 7200RPM, SATA 1.5G/s, 8M
Western Digital	Raptor, WD360GD, 36.7GB, 10000RPM, SATA 1.5Gb/s, 8M
Western Digital	Caviar RE2, WD4000YR, 400GB, 7200RPM, SATA 1.5Gb/s, 16M, NCQ
Western Digital	RE2, WD4000YS, 400GB, 7200RPM, SATA 3.0Gb/s, 16M
Western Digital	Caviar RE16, WD5000AAKS, 500GB, 7200RPM, SATA 3.0Gb/s, 16M
Western Digital	RE2, WD5000ABYS, 500GB, 7200RPM, SATA 3.0Gb/s, 16M, NCQ

RS16FSsupports SAS disk.

Vendor	Model
Hitachi	Ultrastar 15K147, HUS151436VLS300, 36GB, 15000RPM, SAS 3.0Gb/s, 16M
Seagate	Cheetah 15K.4, ST336754SS, 36.7GB, 15000RPM, SAS 3.0Gb/s, 8M
Seagate	Cheetah 15K.5, ST373455SS, 73.4GB, 15000RPM, SAS 3.0Gb/s, 16M
Seagate	Cheetah 15K.5, ST3146855SS, 146.8GB, 15000RPM, SAS 3.0Gb/s, 16M
Seagate	Cheetah NS, ST3400755SS, 400GB, 10000RPM, SAS 3.0Gb/s, 16M

Seagate	Barracuda ES.2, ST31000640SS, 1000GB, 7200RPM, SAS 3.0Gb/s, 16M
---------	---

B. Event notifications

- **PD events**

Level	Type	Description
INFO	Disk inserted	Disk <slot> is inserted into system.
WARNING	Disk removed	Disk <slot> is removed from system.
ERROR	HDD failure	Disk <slot> is disabled.

- **HW events**

Level	Type	Description
WARNING	ECC error	Single-bit ECC error is detected.
ERROR	ECC error	Multi-bit ECC error is detected.
INFO	ECC info	ECC memory is installed.
INFO	ECC info	Non-ECC memory is installed.
INFO	SCSI info	Received SCSI Bus Reset event at the SCSI Bus <number>.

- **EMS events**

Level	Type	Description
INFO	Power installed	Power <number> is installed.
ERROR	Power absent	Power <number> is absent.
INFO	Power work	Power <number> is restored to work.
ERROR	Power warning	Power <number> is out of work.
WARNING	Power detect	PSU signal detection <number>.
INFO	Fan work	Fan <number> is restored to work.
ERROR	Fan warning	Fan <number> is out of work.
INFO	Fan installed	Fan <number> is installed.
ERROR	Fan not present	Fan <number> is not present.
WARNING	Thermal warning	System temperature <location> is a little bit higher.
ERROR	Thermal critical	System Overheated <location>!!!
ERROR	Thermal critical shutdown	System Overheated <location>!!! The system will do the auto shutdown immediately.
WARNING	Thermal ignore value	Unable to update thermal value on <location>.
WARNING	Voltage warning	System voltage <location> is a little bit higher/lower.

ERROR	Voltage critical	System voltages <location> failed!!!
ERROR	Voltage critical shutdown	System voltages <location> failed!!! The system will do the auto shutdown immediately.
INFO	UPS info	UPS detection succeeded.
WARNING	UPS error	UPS detection failed.
ERROR	UPS error	AC loss for the system is detected.
ERROR	UPS error	UPS Power Low!!! The system will do the auto shutdown immediately.
WARNING	SMART T.E.C.	Disk <slot> S.M.A.R.T. Threshold Exceed Condition occurred for attribute <item>.
WARNING	SMART failure	Disk <slot>: Failure to get S.M.A.R.T information.

- **RMS events**

Level	Type	Description
INFO	Console Login	<username> login from <IP or serial console> via Console UI.
INFO	Console Logout	<username> logout from <IP or serial console> via Console UI.
INFO	Web Login	<username> login from <IP> via Web UI.
INFO	Web Logout	<username> logout from <IP> via Web UI.

- **LVM3 events**

Level	Type	Description
INFO	RG created	RG <name> has been created.
INFO	RG creation failed	Failed to create RG <name>.
INFO	RG deleted	RG <name> has been deleted.
INFO	VD created	VD <name> has been created.
INFO	VD creation failed	Failed to create VD <name>.
INFO	VD deleted	VD <name> has been deleted.
INFO	VD renamed	Name of VD <name> has been renamed to <name>.
INFO	Read-only caching enabled	Cache policy of VD <name> has been set as read only.
INFO	Writeback caching enabled	Cache policy of VD <name> has been set as write-back.
INFO	Write-through caching enabled	Cache policy of VD <name> has been set as write-through.
INFO	VD extended	Size of VD <name> extends.
INFO	VD initialization started	VD <name> starts initialization.
INFO	VD initialization finished	VD <name> completes the initialization.
WARNING	VD initialization failed	Failed to complete initialization of VD <name>.
INFO	VD rebuild started	VD <name> starts rebuilding.
INFO	VD rebuild finished	VD <name> completes rebuilding.

WARNING	VD rebuild failed	Failed to complete rebuild of VD <name>.
INFO	VD migration started	VD <name> starts migration.
INFO	VD migration finished	VD <name> completes migration.
ERROR	VD migration failed	Failed to complete migration of VD <name>.
INFO	VD scrubbing started	VD <name> starts scrubbing.
INFO	VD scrubbing finished	VD <name> completes scrubbing.
INFO	RG migration started	RG <name> starts migration.
INFO	RG migration finished	RG <name> completes migration.
INFO	RG activated	RG <name> has been manually activated.
INFO	RG deactivated	RG <name> has been manually deactivated.
INFO	VD rewrite started	Rewrite at LBA <address> of VD %s starts.
INFO	VD rewrite finished	Rewrite at LBA <address> of VD %s completes.
WARNING	VD rewrite failed	Rewrite at LBA <address> of VD %s failed.
WARNING	RG degraded	RG <name> is under degraded mode.
WARNING	VD degraded	VD <name> is under degraded mode.
ERROR	RG failed	RG <name> is failed.
ERROR	VD failed	VD <name> is failed.
WARNING	Recoverable read error occurred	Recoverable read error occurred at LBA <address>-<address> of VD <name>.
WARNING	Recoverable write error occurred	Recoverable write error occurred at LBA <address>-<address> of VD <name>.
ERROR	Unrecoverable read error occurred	Unrecoverable read error occurred at LBA <address>-<address> of VD <name>.
ERROR	Unrecoverable write error occurred	Unrecoverable write error occurred at LBA <address>-<address> of VD <name>.
INFO	Dedicated spare configured	PD <slot> has been configured to RG <name> as a dedicated spare disk.
INFO	Global spare configured	PD <slot> has been configured as a global spare disk.
WARNING	PD read error occurred	Read error occurred at LBA <address>-<address> of PD <slot>.
WARNING	PD write error occurred	Write error occurred at LBA <address>-<address> of PD <slot>.
WARNING	Parity wrong when scrubbing	The parity data is wrong at LBA <address>-<address> when scrubbing VD <name>.
WARNING	Data recovered when scrubbing	Data at LBA <address>-<address> has been recovered when scrubbing VD <name>.
INFO	PD freed	PD <slot> has been removed from RG <name>.
INFO	RG imported	Configuration of RG<name> has been imported.
INFO	RG restored	Configuration of RG <name> has been restored.
INFO	VD restored	Configuration of VD <name> has been restored.

- **Snapshot events**

Level	Type	Description
INFO	Snapshot deleted	The snapshot VD <name> has been deleted.
INFO	Snapshot auto	The oldest snapshot VD <name> has been

	deleted	deleted to obtain extra snapshot space.
INFO	Snapshot taken	A snapshot on VD <name> has been taken.
INFO	Snapshot space configured	Set the snapshot space of VD <name> to <number> MB.
INFO	Snapshot rollback started	Snapshot rollback of VD <name> has been started.
INFO	Snapshot rollback finished	Snapshot rollback of VD <name> has been finished.
WARNING	Snapshot quota reached	The quota assigned to snapshot <name> is reached.

- **Battery backup events**

Level	Type	Description
INFO	BBM sync data	Abnormal shutdown detected, start flushing battery-backed data (<number> KB).
INFO	BBM sync data	Abnormal shutdown detected, flushing battery-backed data finishes.
INFO	BBM detected	Battery backup module is detected.
INFO	BBM is good	Battery backup module is good.
INFO	BBM is charging	Battery backup module is charging.
WARNING	BBM is failed	Battery backup module is failed.
INFO	BBM	Battery backup feature is <item>.

- **JBOD events**

Level	Type	Description
INFO	Disk inserted	JBOD <number> disk <slot> is inserted into system.
Warning	Disk removed	JBOD <number> disk <slot> is removed from system.
ERROR	HDD failure	JBOD <number> disk <slot> is disabled.
INFO	JBOD inserted	JBOD <number> is inserted into system
WARNING	JBOD removed	JBOD <number> is removed from system
WARNING	SMART T.E.C	JBOD <number> disk <slot>: S.M.A.R.T. Threshold Exceed Condition occurred for attribute %s
WARNING	SMART Failure	JBOD <number> disk <slot>: Failure to get S.M.A.R.T information
INFO	Dedicated spare configured	JBOD <number> PD <slot> has been configured to RG <name> as a dedicated spare disk.
INFO	Global spare configured	JBOD <number> PD <slot>d has been configured as a global spare disk.
WARNING	PD read error occurred	Read error occurred at LBA <address>-<address> of JBOD <number> PD <slot>.
WARNING	PD write error occurred	Write error occurred at LBA <address>-<address> of JBOD <number> PD <slot>.
INFO	PD freed	JBOD <number> PD <slot> has been removed from RG <name>.

- **System maintenance events**

Level	Type	Description
INFO	System shutdown	System shutdown.
INFO	System reboot	System reboot.
INFO	FW upgrade start	Firmware upgrade start.
INFO	FW upgrade success	Firmware upgrade success.
WARNING	FW upgrade failure	Firmware upgrade failure.

C. Known issues

1. LSI Logic FC HBA LSI7204XP-LC cannot connect with FC switch Brocade BR-220E.

Workaround solution: Use other FC HBA to connect with FC switch Brocade BR-220E.

2. When two controllers (with SAS JBOD expansion) connect to **UltrStor RS16 JS** (SAS JBOD), they cannot detect all PDs of JBOD.

Workaround solution: It's a JBOD limitation.

D. Installation steps for large volume (TB)

Introduction:

ULTRASTOR controllers are capable of supporting large volumes (>2TB) on all product lines. When connecting controllers to 64bit OS installed host/server, the host/server is inherently capable for large volumes from the 64bit address. On the other side, if the host/server is installed with 32bit OS, user has to change the block size to 1KB, 2KB or 4KB to support volumes up to 4TB, 8TB or 16TB, for the 32bit host/server is not LBA (Logical Block Addressing) 64bit supported. For detail installation steps, please refer to following steps below.

Step 1: Configure target

1. Prepare the hard drivers which capacity is over 2TB totally. Follow the example in chapter 3 to create a RG/VD. Then attach LUN.



Tips

If the OS is 64bit, user can set the block size to any available value. If the OS is 32bit, user must change the block size to larger values than 512B. There will be a confirmation pop-up message when VD size is over 2TB.

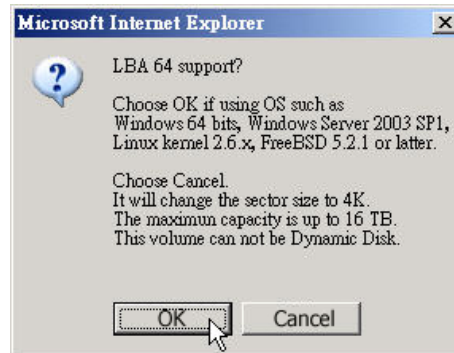

Figure D.1:

(Figure D.1: choose “OK” for 64bit OS, choose “Cancel” for 32bit OS, this step will change block size to 4K automatically.)

2. Mouse moves to the gray button next to the VD number; click “**More information**”. Look at block size is 512B for 64bit OS setting, 4K for 32bit OS setting.

Step 2: Configure host/server

1. Follow the installation guild provided by HBA vendor, install HBA driver properly. For iSCSI models, please install the latest Microsoft iSCSI initiator from the link below.

<http://www.microsoft.com/downloads/details.aspx?FamilyID=12cb3c1a-15d6-4585-b385-befd1319f825&DisplayLang=en>

Step 3: Initialize/Format/Mount the disk

1. Go to Start → Control Panel → Computer Management → Disk Management, it displays a new disk.

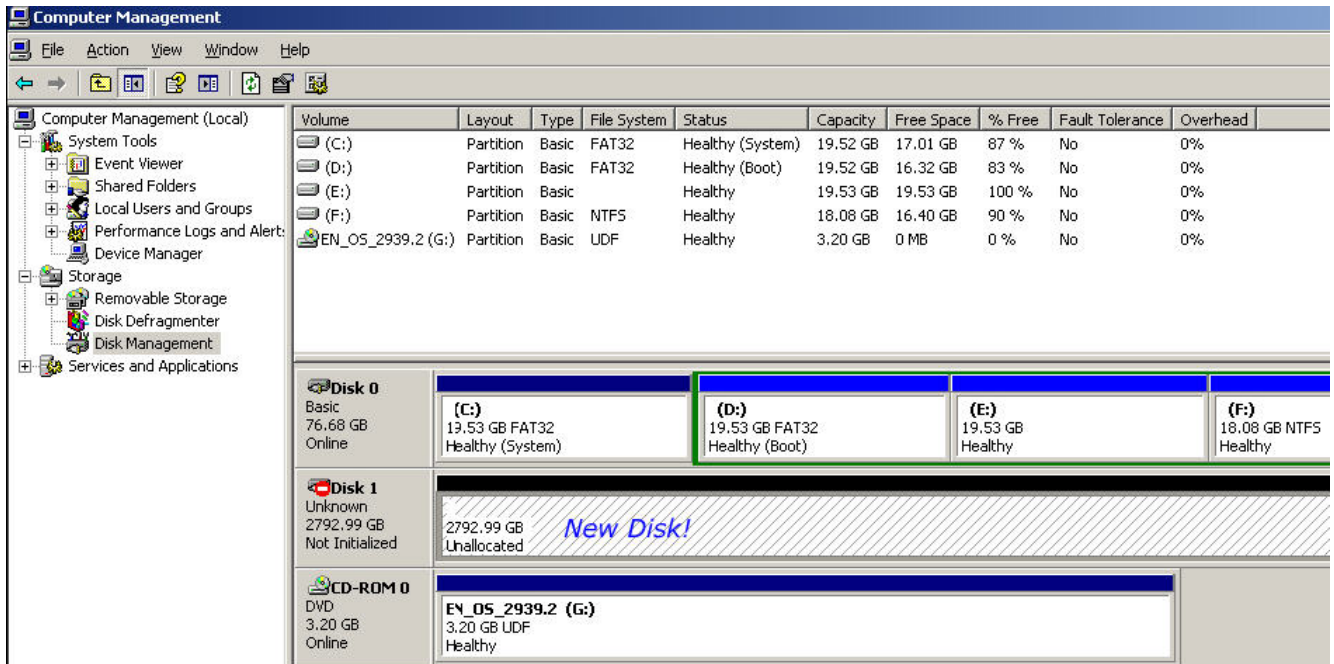

Figure D.2

2. Initialize the disk.

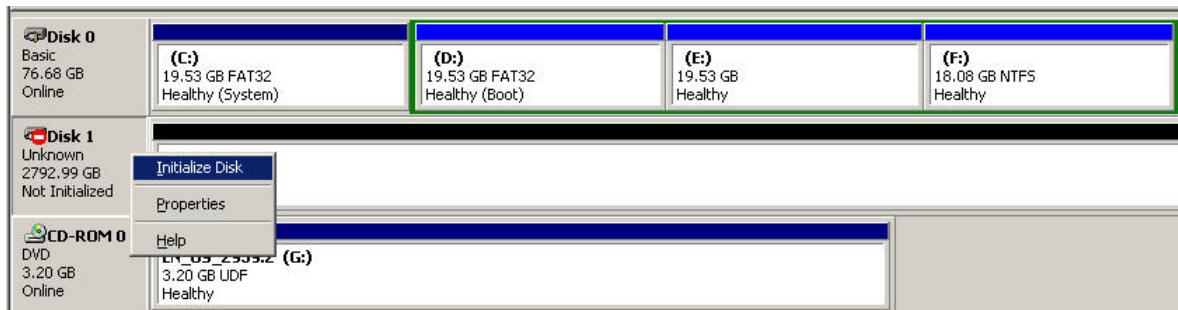

Figure D.3

3. Convert to GPT disk for over 2TB capacity. For more detail information about GPT, please visit

http://www.microsoft.com/whdc/device/storage/GPT_FAQ.mspx

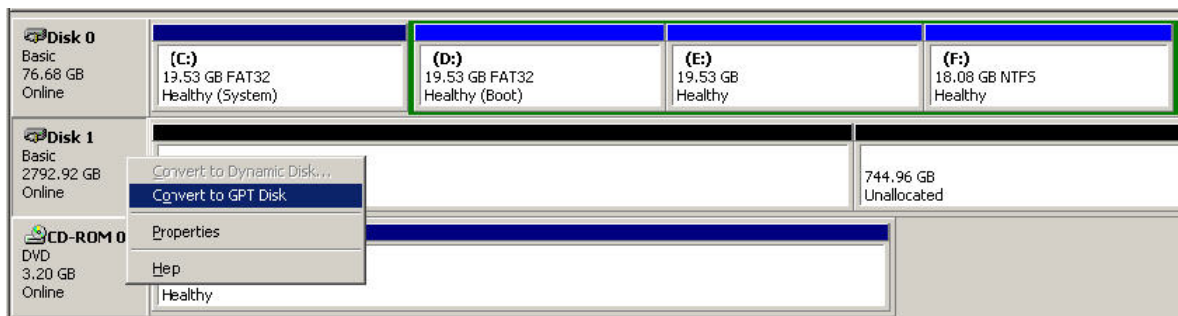

Figure D.4

4. Format the disk.

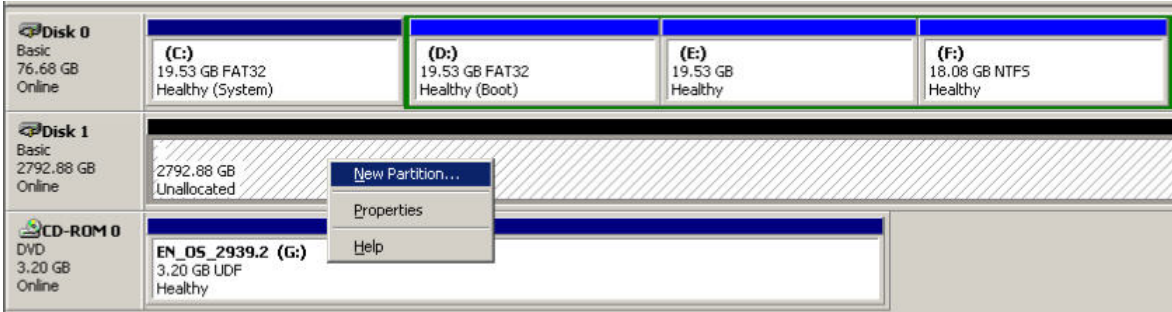

Figure D.5

5. Done.

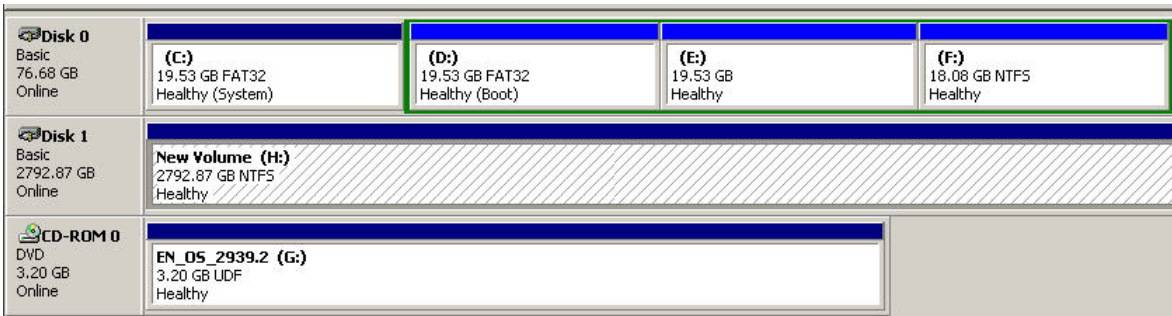

Figure D.6

6. The new disk is ready to use, the available size = 2.72TB.

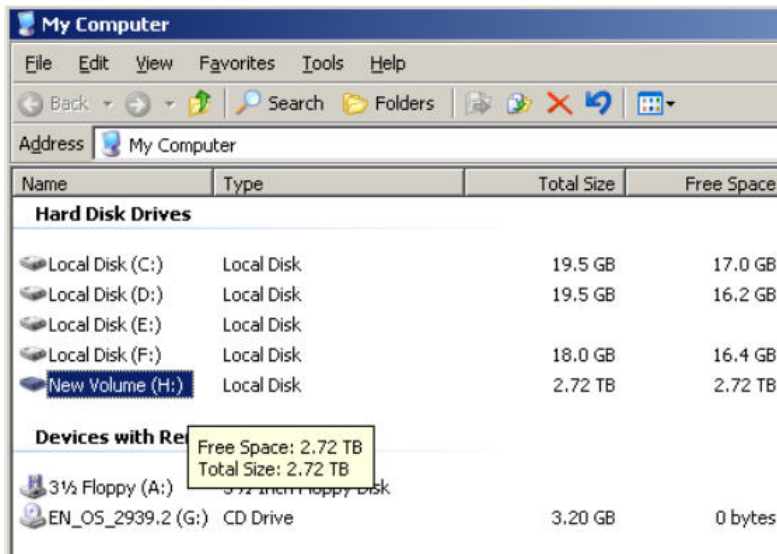



Figure D.7

	<p>Caution</p> <p>If user setups 512B block size for VD and the host/server OS is 32bit, in the last step of formatting disk, user will find OS can not format the disk sector after 2048GB (2TB).</p>
---	---

7. Wrong setting result: OS can not format disk sector after 2048GB (2TB).

<p>Disk 0 Basic 76.68 GB Online</p>	<p>(C:) 19.53 GB FAT32 Healthy (System)</p>	<p>(D:) 19.53 GB FAT32 Healthy (Boot)</p>	<p>(E:) 19.53 GB Healthy</p>	<p>(F:) 18.08 GB NTFS Healthy</p>
<p>Disk 1 Basic 2792.99 GB Online</p>	<p>New Volume (H:) 2048.00 GB NTFS Healthy</p>		<p>744.99 GB Unallocated</p>	<p> <i>OS cannot format this area!</i></p>
<p>CD-ROM 0 DVD 3.20 GB Online</p>	<p>EN_05_2939.2 (G:) 3.20 GB UDF Healthy</p>			

Figure D.8

System information

	ULTRASTOR RS16 FS
SW version	1.0.0